

Operating Manual



Position-preset counter 575

Dual position preset counter and differential indicators for use with two encoders or measuring systems (SSI absolute or incremental)

6.575.0116.D05: 6-digit Position preset-counter, with 4 fast switching outputs and serial interface RS232

6.575.0116.D95: 6-digit Position preset-counter, with 4 fast switching outputs, serial interface RS232 and scalable analog output

6.575.0118.D05: 8-digit Position preset-counter, with 4 fast switching outputs and serial interface RS232

6.575.0118.D95: 8-digit Position preset-counter, with 4 fast switching outputs, serial interface RS232 and scalable analog output

- Electronic Position preset-counter for high-end applications
- 2 independent encoder inputs (each either SSI-Master or SSI-Slave or incremental)
- Display of encoder1, encoder2, [encoder1 - encoder2] or [encoder1 + encoder2]
- 4 presets with very fast responding power transistor outputs
- Models with 6 digits or with 8 digits available

Version:	Description:
6.575_a/af/hk/08_2011	First edition
6.575_b/June12/pp	Corrected images in chapter 1 and 8.2
6.575_c/May13/af/nw	Adjustment of the parameters and control commands
6.575_d/March15/af/ag	Modification in chapter 6.4.2 / Encoder Selection = 4
6.575_01e_oi/March16/ag	Correction on page 7 Correction in section 9.4.2 (ASCII Code 63 instead of 59) New: "Safety Instructions and Responsibility"
6.575_01f/09_2019	Correction in chapter 4.6
6.575 - Index 3, Dez20	OSxx
6.575 – Index 4, Nov21	
6.575 – Index 01g, Sept22	Various revisions: approvals, chapter "EMV Guidelines" added

Legal notices:
All contents included in this manual are protected by the terms of use and copyrights of Fritz Kübler GmbH. Any reproduction, modification, usage, or publication in other electronic and printed media as well as on the internet requires prior written authorization by Fritz Kübler GmbH.

Table of Contents

1. Safety Instructions and Responsibility	4
1.1. General Safety Instructions.....	4
1.2. Use according to the intended purpose	4
1.3. Installation	5
1.4. EMC Guidelines	5
1.5. Cleaning, Maintenance and Service Notes	6
2. Survey of Available Models	7
3. Introduction	8
4. Terminal Assignments, Electrical Connections	9
4.1. Power Supply	11
4.2. Auxiliary Outputs for Encoder Supply	11
4.3. Encoder Inputs	11
4.4. Control Inputs Cont.1 – Cont.4	11
4.5. Switching Outputs K1 – K4	12
4.6. Serial Interface	12
4.7. Fast Analogue Output (only models xxx.D95).....	12
5. Modes of Operation	13
5.1. One SSI Encoder only (Single-Read Operation).....	15
5.2. One SSI Encoder only (Double-Read Operation).....	16
5.3. Evaluation of Two Independent SSI Encoders	17
5.4. Summation of Two SSI Encoders {Encoder1 + Encoder2}.....	18
5.5. Differential Evaluation of Two SSI Encoders {Encoder1 - Encoder2}.....	19
5.6. Mixed Operations (SSI Encoder with Incremental Encoder).....	20
6. Keypad Operation	21
6.1. Normal Operation	21
6.2. General Setup Procedure	21
6.3. Direct Fast Access to Presets	22
6.4. Change of Parameter Values on the Numeric Level	23
6.5. Code Protection against Unauthorized Keypad Access	24
6.6. Return from the Programming Levels and Time-Out Function	24
6.7. Reset all Parameters to Factory Default Values.....	24
7. Menu Structure and Description of Parameters	25
7.1. Summary of the Menu	25
7.2. Functional Overview of the Parameter groups.....	27
7.3. Important Hints.....	28
7.4. Detailed Description of Parameters.....	29
8. Hints for Use of the SSI Indicator	41
8.1. Master- und Slave-Betrieb (with use of SSI encoders)	41
8.2. Bit Evaluation (with use of SSI encoders).....	42
8.3. Scaling of the SSI Indicator	43
8.4. Basic Operation Modes of the Indicator	45
9. Appendix: Serial Communication Details	50
9.1. Setup of the Unit by PC.....	50
9.2. Automatic, Cyclic Data Transmission	51
9.3. Communication Protocol	51
9.4. Serial Access Codes	53
10. Technical Data	54
11. Dimensions	55

1. Safety Instructions and Responsibility

1.1. General Safety Instructions

This operation manual is a significant component of the unit and includes important rules and hints about the installation, function and usage. Non-observance can result in damage and/or impairment of the functions to the unit or the machine or even in injury to persons using the equipment.

Please read the following instructions carefully before operating the device and observe all safety and warning instructions. Keep the manual for later use.

A pertinent qualification of the respective staff is a fundamental requirement in order to use this manual. The unit must be installed, configured, commissioned and serviced by a qualified electrician.

Liability exclusion: The manufacturer is not liable for personal injury and/or damage to property and for consequential damage, due to incorrect handling, installation, operation and maintaining. Further claims, due to errors in the operation manual as well as misinterpretations are excluded from liability. In addition, the manufacturer reserves the right to modify the hardware, software or operation manual at any time and without prior notice. Therefore, there might be minor differences between the unit and the descriptions in operation manual.

The raiser respectively positioner is exclusively responsible for the safety of the system and equipment where the unit will be integrated.

During installation, operation or maintenance all general and also all country- and application-specific safety rules and standards must be observed.

If the device is used in processes, where a failure or faulty operation could damage the system or injure persons, appropriate precautions to avoid such consequences must be taken.

1.2. Use according to the intended purpose

The unit is intended exclusively for use in industrial machines, constructions, and systems. Non-conforming usage does not correspond to the provisions and lies within the sole responsibility of the user. The manufacturer is not liable for damages which has arisen through unsuitable and improper use.

Please note that device may only be installed in proper form and used in a technically perfect condition in accordance with the “Technical Specifications” (see chapter [10](#)). The device is not suitable for operation in explosion-proof areas or areas which are excluded by the EN 61010-1 standard.

1.3. Installation

The device is only allowed to be installed and operated within the permissible temperature range. Please ensure an adequate ventilation and avoid all direct contact between the device and hot or aggressive gases and liquids.

Before installation or maintenance, the unit must be disconnected from all voltage-sources. Further it must be ensured that no danger can arise by touching the disconnected voltage-sources.

Devices which are supplied by AC-voltages, must be connected exclusively by switches, respectively circuit-breakers with the low voltage network. The switch or circuit-breaker must be placed as near as possible to the device and further indicated as separator.

Incoming as well as outgoing wires and wires for extra low voltages (ELV) must be separated from dangerous electrical cables (SELV circuits) by using a double resp. increased isolation.

All selected wires and isolations must be conforming to the provided voltage- and temperature-ranges. Further all country- and application-specific standards, which are relevant for structure, form and quality of the wires, must be ensured. Indications about the permissible wire cross-sections for wiring are described in the “Technical Specifications” chapter.

Before first start-up it must be ensured that all connections and wires are firmly seated and secured in the screw terminals. All (inclusively unused) terminals must be fastened by turning the relevant screws clockwise up to the stop.

Overvoltages at the connections must be limited to values in accordance to the overvoltage category II.

1.4. EMC Guidelines

All devices are designed to provide high protection against electromagnetic interference. Nevertheless, you must minimize the influence of electromagnetic noise to the device and all connected cables.

Therefore, the following measures are mandatory for a successful installation and operation:

- **Use shielded cables for all signal and control input and output lines.**
- **Cables for digital controls (digital I/O, relay outputs) must not exceed a length of 30 m and are allowed for in building operation only**
- Use shield connection clamps to connect the cable shields properly to earth
- The wiring of the common ground lines must be star-shaped and common ground must be connected to earth at only one single point
- The device should be mounted in a metal enclosure with sufficient distance to sources of electromagnetic noise.

- Run signal and control cables apart from power lines and other cables emitting electromagnetic noise.

Please also refer to the pocket guide “General Rules for Cabling, Grounding, Cabinet Assembly”. You can download that document by the link <https://www.kuebler.com/emc>.

1.5. Cleaning, Maintenance and Service Notes

To clean the front of the unit please use only a slightly damp (not wet!), soft cloth. For the rear no cleaning is necessary. For an unscheduled, individual cleaning of the rear the maintenance staff or assembler is self-responsible.

During normal operation no maintenance is necessary. In case of unexpected problems, failures or malfunctions the device must be shipped for back to the manufacturer for checking, adjustment and reparation (if necessary). Unauthorized opening and repairing can have negative effects or failures to the protection-measures of the unit.

2. Survey of Available Models

The counters series 6.575 consisting of the following device types.

All 6 versions have completely identical basic functions and differ only in the display and the outputs.



6.575.0116.D05:

Display 6 digits, 14.22 mm digit height
4 fast switching outputs
RS232 interface



6.575.0118.D05:

Display 8 digits, 9.15 mm digit height
4 fast switching outputs
RS232 interface



6.575.0116.D95

Display 6 digits, 14.22 mm digit height
4 fast switching outputs
Fast, scalable analogue output
RS232 interface

6



6.575.0118.D95

Display 8 digits, 9.15 mm digit height
4 fast switching outputs
Fast, scalable analogue output
RS232 interface

3. Introduction

The counters of series 575 have been designed to close a gap with multiple indicating and counting applications which cannot be accomplished by the standard SSI indicators or incremental counters available on the market.

Many applications require to evaluate the signals of two SSI measuring systems, and to compare the results with respect to the sum or the difference. With other applications it is necessary to compare position signals from an SSI encoder with other information coming from an incremental encoder.

Particularly with fast running procedures it is most important to have fast response of the switching outputs or the analogue output.

These are some of the major reasons why this new series of indicators have been designed.



- **This manual at first provides all basic instructions for operation of the indicator models presented in the previous chapter.**
- **The operator software “OSxx” is available for convenient commissioning of the devices via PC (free download from www.kuebler.com).**
- **Where you like to use free serial access to the units by PLC or IPC or by a remote operator terminal, please observe the serial protocol details described in our separate manual named “Serpro”.**
- **Subsequently this manual uses the expression 575 as a replacement for all available models. Please note that all statements are fully valid for the other models too, except where especially remarked.**

4. Terminal Assignments, Electrical Connections

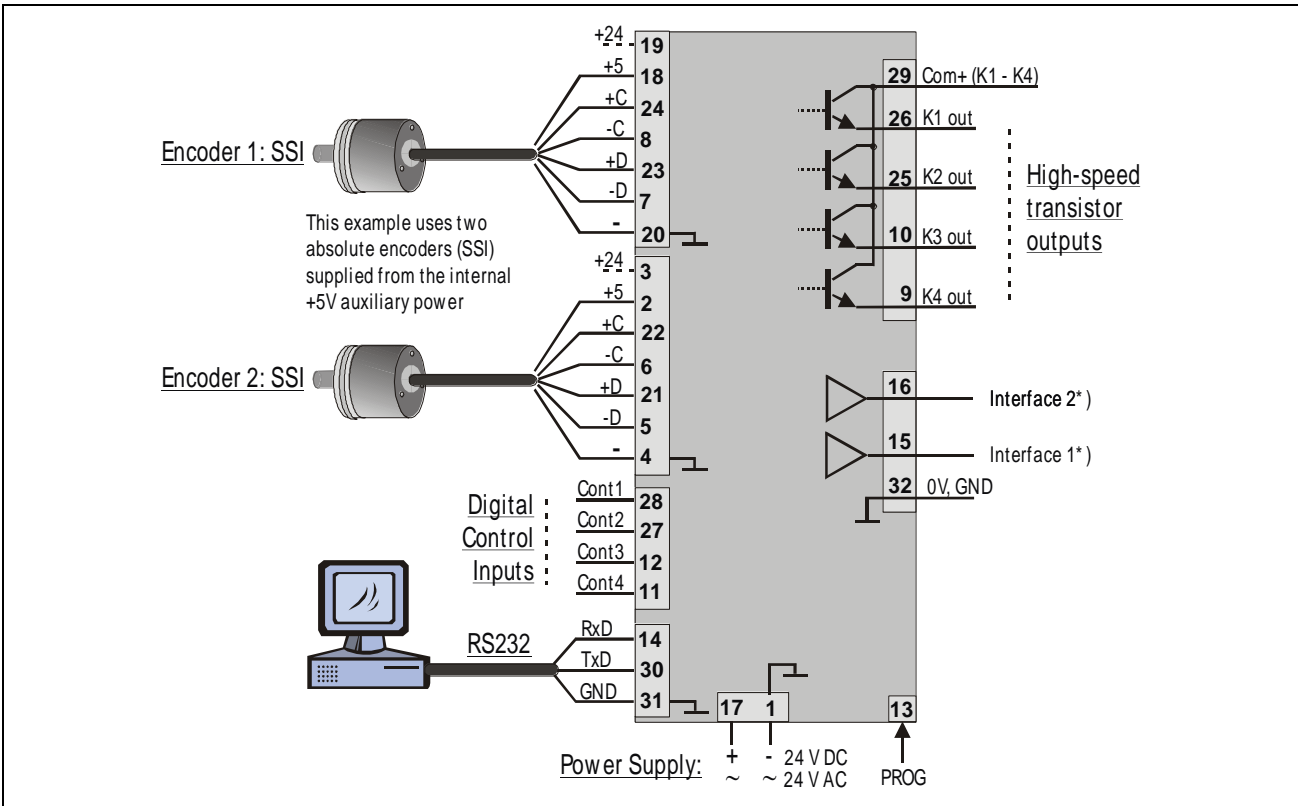
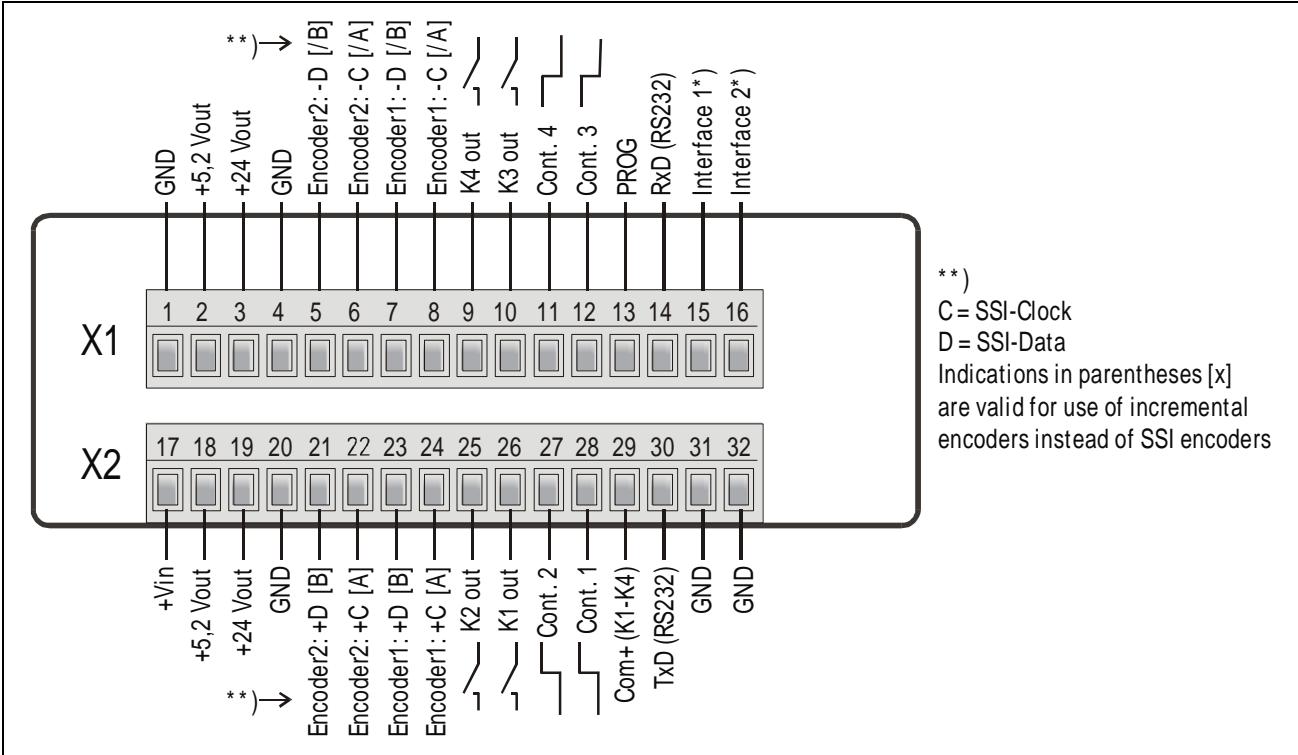

	Series xxx.D05	Series xxx.D95
*) Interface 1:	- n.c. -	Analogue output 0/4 - 20 mA
*) Interface 2:	- n.c. -	Analogue output +/- 10 V

Terminal	Name	Function
01	GND	Common Ground Potential (0V)
02	+5,2V out	Aux. output 5.2 V/150 mA for encoder supply
03	+24V out	Aux. output 24 V/120 mA for encoder supply
04	GND	Common Ground Potential (0V)
05	Encoder2, -D [/B]	SSI Encoder: Data line, inverted signal Incremental Encoder: Impulse input /B (=B inverted)
06	Encoder2, -C [/A]	SSI Encoder: Clock line, inverted signal Incremental Encoder: Impulse input /A (=A inverted)
07	Encoder1, -D [/B]	SSI Encoder: Data line, inverted signal Incremental Encoder: Impulse input /B (=B inverted)
08	Encoder1, -C [/A]	SSI Encoder: Clock line, inverted signal Incremental Encoder: Impulse input /A (=A inverted)
09	K4 out	Switching output K4 (transistor PNP 30V/350 mA)
10	K3 out	Switching output K3 (transistor PNP 30V/350 mA)
11	Cont.4	Control input for digital commands
12	Cont.3	Control input for digital commands
13	(PROG)	(reserved for download of new unit firmware)
14	RxD	Serial RS232 Interface, „Receive Data“ (input)
15	Interface 1	.D05: n.c. (no function) .D95: Analogue current output 0/4 - 20 mA
16	Interface 2	.D05: n.c. (no function) .D95: Analogue voltage output +/- 10 V
17	+Vin	Power Supply Input +17 – 40 VDC or 24 VAC
18	+5,2V out	Aux. output 5.2 V/150 mA for encoder supply
19	+24V out	Aux. output 24 V/120 mA for encoder supply
20	GND	Common Ground Potential (0V)
21	Encoder2, +D [B]	SSI Encoder: Data line, non-inverted signal Incremental Encoder: Impulse input B (=B non inverted)
22	Encoder 2, +C [A]	SSI Encoder: Clock line, non-inverted signal Incremental Encoder: Impulse input A (=A non inverted)
23	Encoder 1, +D [B]	SSI Encoder: Data line, non-inverted signal
24	Encoder 1, +C [A]	SSI Encoder: Clock line, non-inverted signal
25	K2 out	Switching output K2 (transistor PNP 30V/350 mA)
26	K1 out	Switching output K1 (transistor PNP 30V/350 mA)
27	Cont.2	Control input for digital commands
28	Cont.1	Control input for digital commands
29	Com+ (K1-K4)	Common input for the switching voltage of outputs K1-K4
30	TxD	Serial RS232 Interface, „Transmit Data“ (output)
31	GND	Common Ground Potential (0V)
32	GND	Common Ground Potential (0V) and Minus for DC or AC power

*) 120 mA and 150 mA are per encoder, i.e. total maximum currents are 240 mA and 300 mA

4.1. Power Supply

The device accepts both, a 17 – 40 volts DC power or a 24 volts AC power for supply via terminals 17 and 1. The current consumption depends on the level of the input voltage and some internal conditions; therefore, it can vary in a range from 100 – 200 mA (aux. currents taken from the unit for encoder supply not included).

4.2. Auxiliary Outputs for Encoder Supply

Terminals 2 and 18 provide an auxiliary output with approx. +5.2 volts DC (300 mA totally). Terminals 3 and 19 provide an auxiliary output with approx. +24 volts DC (240 mA totally).

4.3. Encoder Inputs

The unit provides two independent encoder inputs which can be configured for use with either **SSI Absolute Encoders** or for **use with Incremental Encoders**.

The following combinations of encoders are possible:

Encoder 1	Encoder 2	
SSI	SSI	✓
SSI	incremental	✓
incremental	SSI	✗
incremental	incremental	✗



- In case of use of incremental encoders, it is mandatory they have differential TTL output (5 V), i.e. channels A, /A, B and /B are required.
- The incremental encoder inputs will accept the quadrature impulse format (A, B, 2 x 90°) as well as a static direction information (A = impulse, B = direction).
- Units of this series require at least one of the two encoders to be SSI absolute. For applications using two incremental encoders please refer to models 572.

4.4. Control Inputs Cont.1 – Cont.4

These inputs can be configured for various remote functions like Reset, Inhibit etc. All control inputs require HTL level. They can be individually set to either NPN (switch to -) or PNP (switch to +) characteristics. For applications where edge-triggered action is needed, the menu allows to set the active edge (rising or falling). Control inputs also accept signals with Namur (2-wire) standard.

For reliable operation the minimum pulse width on the control inputs should be 50 µsec.

4.5. Switching Outputs K1 – K4

The devices provide four presets and outputs with programmable switching characteristics.

K1 – K4 are fast-switching and short-circuit-proof transistor outputs with a switching capability of 5 – 30 volts / 350 mA each. The switching voltage of the outputs must be applied remotely to the Com+ input (terminal 29).

4.6. Serial Interface

The serial interfaces RS232 can be used for the following purposes:

- Set-up of the unit by PC (if desirable), by means of the OSxx PC software
- Change of parameters during operation
- Readout of actual positions or other information by PLC or PC

The drawings below explain how to connect the RS232 interface with a PC via standard SUB-D-9 connector. Details about the communication profile can be found in chapter [9](#).

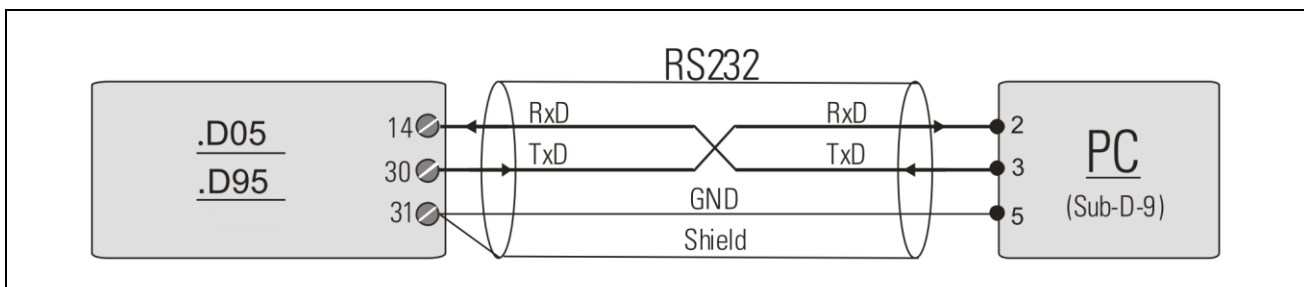

4.7. Fast Analogue Output (only models xxx.D95)

An analogue output is available with all IA models, providing a voltage output of +/- 10 volts (Load = 3 mA), and a current output of 0 – 20 mA or 4 – 20 mA (load = 0 – 270 Ohms). All output characteristics like beginning of conversion range, output swing etc. are freely programmable via menu. The response time of the analogue output is less than 1 msec. (time from encoder event to analogue out). The resolution is 14 bits.

Please note that extensive serial communication with the unit may temporarily increase the analogue response time.

5. Modes of Operation

For best survey, all parameters of the unit are arranged in 13 expedient groups, named “F01” - “F13”. Depending on the application, only a few of these groups may be important, while all other groups may be irrelevant for your specific application.

This chapter describes the modes of operation and applications with consideration of the possible combinations of encoders (SSI and incremental).

Parameter F02.008 (Encoder Selection) provides setting of the desired encoder combination.

Parameter F02.009 (Operational Mode) provides setting of the mode of operation of the unit.

The subsequent table imparts a survey of all possible functions of the ID340 indicator series:

Encoder Combination	Function	Chapter
Encoder 1 = SSI (single-read*) Encoder 2 = n.a.	Evaluation of one SSI encoder only (encoder input 1), singular reading of the SSI telegram (no cross-check *)	5.1
Encoder 1 = SSI (double-read*) Encoder 2 = n.a.	Evaluation of one SSI encoder only (encoder input 1), double reading of the SSI telegram (cross-check to ensure correct reading *)	5.2
Encoder 1 = SSI Encoder 2 = SSI	Two independent SSI encoders, evaluation of the individual encoder results or the sum or the difference of both encoders	5.3 5.4 5.5
Encoder 1 = SSI Encoder 2 = incremental	One SSI encoder (1) and one incremental encoder (2), evaluation of the individual encoder results or the sum or the difference of both encoders	5.6
Neutral state (default setting) for initial commissioning	Factory setting to avoid possible damage when using the unit the very first time	see hint 7.3







*) **Single-read:** the total length of the SSI telegram results from the encoder resolution. Data will be evaluated directly without any cross-check.
Double-read: the unit uses double telegram length and two consecutive samples will be read in a short distance one to another. Both readings will be checked for consistency and an error message will be indicated upon inequality (see 8.4.6).



Hints for Operation of Display, Switching Outputs and Analogue Outputs

- **At any time during operation the display of the unit can be switched over to different readings, as shown in the subsequent function tables** (assignment of the Display Scrolling Function to one of the keys or the inputs is required for scrolling the display, see menu F06).
- **The LEDs L1 and L2 are used to indicate which of the available values is actually on display (LED states are on, off or blinking at low or high speed). The following symbols are used subsequently to indicate the actual LED behavior:**

	LED is OFF
	LED is ON
	LED is blinking slowly (1 / sec.)
	LED is blinking quickly (3 / sec.)

- **Scrolling of the display from one reading mode to another will not affect the function of the preselection outputs K1 – K4.**
- **The analogue output (models xxx.D95) can be assigned to any of the readings accessible in the display, by a special parameter. Scrolling of the display from one reading mode to another will not affect the analogue output.**



For best comprehension the following chapters use square brackets whenever names or settings of parameters are mentioned, e.g. [SSI-Mode] = [1].

5.1. One SSI Encoder only (Single-Read Operation)

F02.008 [Encoder-Selection] = [0] F02.009 [Operational Mode] = [0]

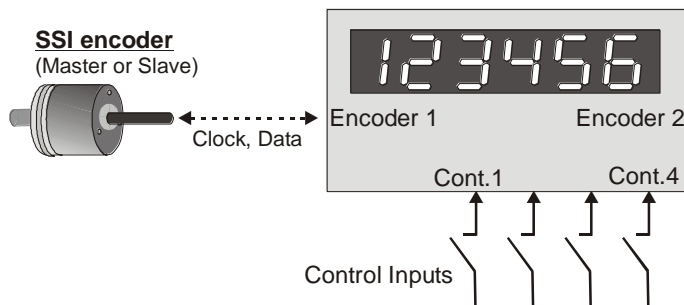

One SSI encoder only is connected to the unit.

Encoder data are read in a continuous cycle according to the selected number of encoder bits and the baud rate setting. Every telegram will be evaluated right away without cross-check.

Parameter F03.021 [SSI-Mode] provides setting of encoder input 1 to either Master operation or Slave operation (see also chapter [8.1](#)).

All four preselections [Preselection 1] - [Preselection 4] refer to the actual position of encoder 1.

By keypad or external command, the indication on the display can be scrolled between the following values:

No.	Value in display	LED1	LED2
1	Actual value of encoder 1 according to scaling		
2	Minimum value of encoder 1 (since last Min/Max. Reset command)		
3	Maximum value of encoder 1 (since last Min/Max. Reset command)		

5.3. Evaluation of Two Independent SSI Encoders

F02.008 [Encoder-Selection] = [2] F02.009 [Operational Mode] = [0]

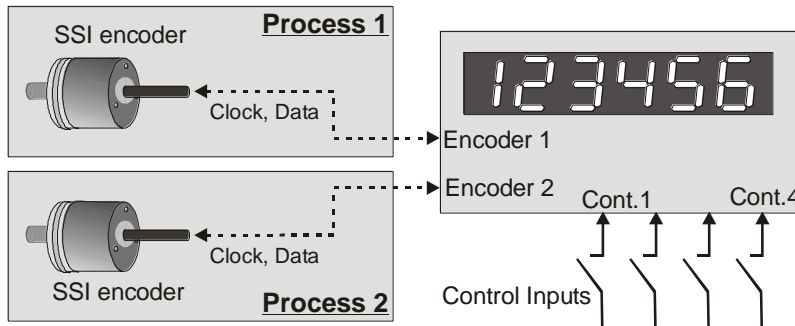

Both encoder inputs are connected to SSI encoders for individual evaluation. The encoders may have different resolutions and can operate at different Baud rates and individual scaling.

Parameter F03.021 [SSI-Mode1] assigns Master or Slave operation to encoder 1 and Parameter F04.039 [SSI-Mode2] assigns Master or Slave operation to encoder 2 (see also chapter 8.1)

The settings of [Preselection 1] and [Preselection 2] refer to the actual position of encoder 1.

The settings of [Preselection 3] and [Preselection 4] refer to the actual position of encoder 2.

By keypad or external command, the indication on the display can be scrolled between the following values:

No.	Value in display	LED1	LED2
1	Actual value of encoder 1 according to scaling		
2	Minimum value of encoder 1 (since last Min/Max. Reset command)		
3	Maximum value of encoder 1 (since last Min/Max. Reset command)		
4	Actual value of encoder 2 according to scaling		
5	Minimum value of encoder 2 (since last Min/Max. Reset command)		
6	Maximum value of encoder 2 (since last Min/Max. Reset command)		

5.4. Summation of Two SSI Encoders {Encoder1 + Encoder2}

F02.008 [Encoder-Selection] = [2] F02.009 [Operational Mode] = [1]

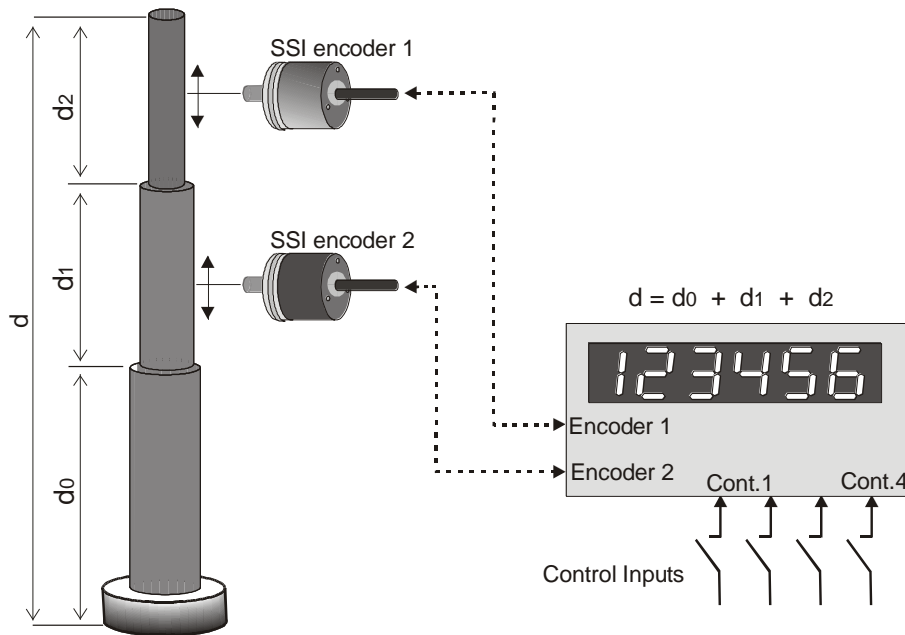

Both encoder inputs are connected to SSI encoders and the unit calculates the sum of positions of both encoders. The encoders may have different resolutions and can operate at different Baud rates and individual scaling. The result of the calculation (sum) can once more be converted to the desired engineering units by means of the final scaling parameters.

Parameter F03.021 [SSI-Mode1] assigns Master or Slave operation to encoder 1 and parameter F04.039 [SSI-Mode2] assigns Master or Slave operation to encoder 2 (see also chapter 8.1)

The setting of [Preselection 1] refers to the actual position of encoder 1.

The setting of [Preselection 2] refers to the actual position of encoder 2.

The settings of [Preselection 3] and [Preselection 4] refer to the actual sum of both positions.

By keypad or external command, the indication on the display can be scrolled between the following values:

No.	Value in display	LED1	LED2
1	Actual value of the sum [encoder 1] + [encoder 2] according to scaling		
2	Minimum value of the sum (since last Min/Max. Reset command)		
3	Maximum value of the sum (since last Min/Max. Reset command)		
4	Actual value of encoder 1 alone, according to scaling		
5	Actual value of encoder 2 alone, according to scaling		

5.5. Differential Evaluation of Two SSI Encoders {Encoder1 - Encoder2}

F02.008 [Encoder-Selection] = [2]

F02.009 [Operational Mode] = [2]

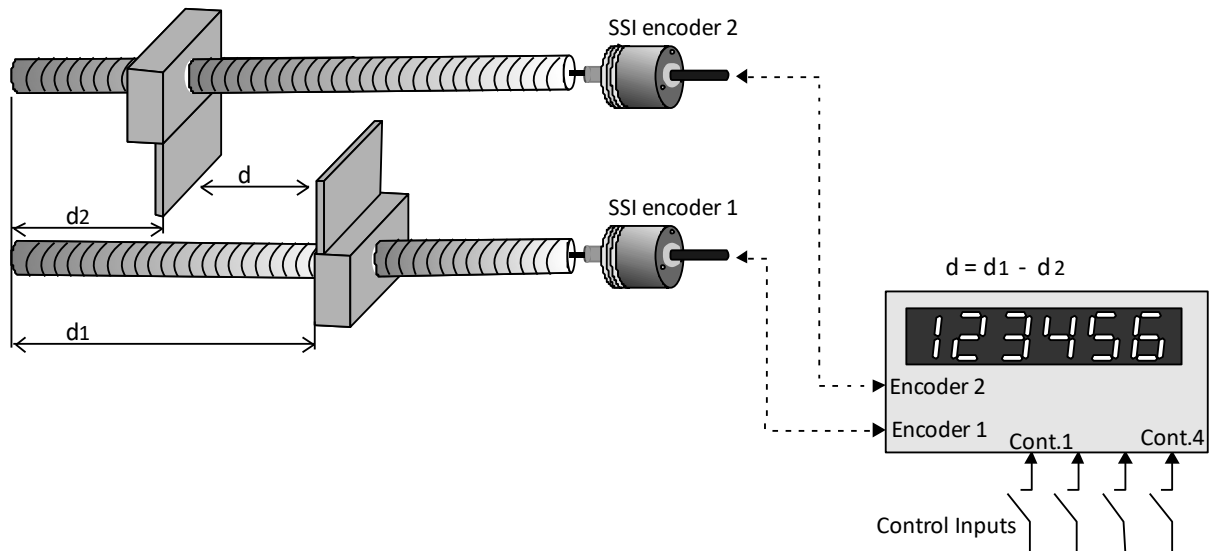

Both encoder inputs are connected to SSI encoders and the unit calculates the differential position of both encoders. The encoders may have different resolutions and can operate at different Baud rates and individual scaling. The result of the calculation (difference) can once more be converted to the desired engineering units by means of the final scaling parameters.

Parameter F03.021 [SSI-Mode1] assigns Master or Slave operation to encoder 1 and parameter F04.039 [SSI-Mode2] assigns Master or Slave operation to encoder 2 (see also chapter 8.1)

The setting of [Preselection 1] refers to the actual position of encoder 1.
 The setting of [Preselection 2] refers to the actual position of encoder 2.
 The settings of [Preselection 3] and [Preselection 4] refer to the actual differential position.

By keypad or external command, the indication on the display can be scrolled between the following values:

No.	Value in display	LED1	LED2
1	Actual differential value [encoder 1] - [encoder 2] according to scaling	●	●
2	Minimum value of the difference (since last Min/Max. Reset command)	●1	●1
3	Maximum value of the difference (since last Min/Max. Reset command)	●3	●3
4	Actual value of encoder 1 alone, according to scaling	●	○
5	Actual value of encoder 2 alone, according to scaling	○	●

5.6. Mixed Operations (SSI Encoder with Incremental Encoder)

With appropriate setting of the parameter [Encoder Selection] the unit will also accept combinations from SSI Encoders and Incremental Encoders instead of two SSI Encoders. The table below shows how to set the relevant parameters for mixed encoder operations.

Encoder Configuration	Function of the unit	[Encoder Selection]	[Operational Mode]
Encoder 1 = SSI Encoder 2 = inkremental	Independent encoder operation (like 5.3)	[3]	[0]
	Summation (like 5.4)	[3]	[1]
	Differential evaluation (like 5.5)	[3]	[2]



With all modes of operation, the two encoders will be scaled by their separate and individual scaling factors. It is important to understand that the display will at any time only indicate the integer part of a scaling result, whereas remainder values will be carried in the background.





Example: calculation of the difference between both encoders with remainders:

Enc. 1		Scaling Enc. 1		Enc. 2		Scaling Enc. 2		Display	Remainder (background)
1000	x	0,98765	minus	2000	x	1,23456			
967,65000			-	2469,12000			=	-1501	0,47000

6. Keypad Operation

An overview of all parameters and explanations can be found under section 6.

The menu of the unit uses four keys, in this description named as follows:

			
PROG	UP	DOWN	ENTER

Key functions depend on the actual operating state of the unit. Essentially, we must describe three basic states:

- **Normal operation**
- **General setup procedure**
- **Direct fast access to presets and set values**

6.1. Normal Operation









In this mode the unit operates as a counter according to the settings defined upon setup. All front keys may have customer-defined functions according to the specifications met in the keypad definition menu F06 (e.g. scrolling of the display, Reset etc.)

6.2. General Setup Procedure

The unit changes over from normal operation to setup level when keeping the key  down for at least 2 seconds. Thereafter you can select one of the parameter groups F01 to F13.

Inside the group you can now select the desired parameter and set the value according to need. After this you can either set more parameters or return to the normal operation.

The programming sequence shown on the next page explains how to change Parameter number 052 of group F06 from the original value of 0 to the new value of 8.

Step	State	Key action	Display	Comment
00	Normal operation		Counting	
01		 > 2 sec.	F01	Display of the Parameter group
02	Level: Parameter group	 5 x	F02 ... F06	Select group # F06
03			F06.050	Confirmation of F06. The first parameter of this group is F06.050
04	Level: Parameter numbers	 2 x	F06.051... F06.052	Select parameter 052
05			0	Parameter 052 appears in display, actual setting is 0
06	Level: Parameter values	 8 x	1 ... 8	Setting has been modified from 0 to 8
07			F06.052	Save the new setting (8)
08	Level: Parameter numbers		F06	Return to level parameter groups
09	Level: Parameter groups		Counting	Return to normal operation
10	Normal operation			



During the general setup procedure all evaluation activities remain disabled. New parameter settings become active after return to normal operation only.

6.3. Direct Fast Access to Presets

To get to the fast access routine, please press both

 and  at the same time





This will access the parameter group F01 right away. To change of the settings, follow the same procedure as already described above. Besides the advantage of direct access, the fundamental difference to general setup is the following:



During the fast access procedure all unit functions remain fully active. Access is limited to presets; no other parameters can be changed.











6.4. Change of Parameter Values on the Numeric Level

The numeric range of the parameters is up to 6 digits with 6-decade models and up to 8 digits with 8 decade models. Some of the parameters may also include a sign. For fast and easy setting of these values the menu uses an algorithm as shown subsequently. During this operation the front keys have the following functions:

			
PROG	UP	DOWN	ENTER
Saves the actual value shown in the display and returns to the parameter selection level	Increments the highlighted (blinking) digit	Decrements the highlighted (blinking) digit	Shifts the cursor (blinking digit) one position to the left, or from utmost left to right

With signed parameters the left digit scrolls from **0 to 9** and then shows “-”, (negative) and “-1” (minus one). The example below shows how to change a parameter from the setting 1024 to the new setting 250 000 (using a 6 decade model).

This example assumes that you have already selected the parameter group and the parameter number, and that you actually read the parameter value in the display. Highlighted digits appear on colored background.

Step	Display	Key action	Comment
00	001024		Display of actual parameter setting, last digit is highlighted
01		 4 x or scroll	Scroll last digit down to 0
02	001020		Shift cursor to left
03	001020	 2 x or scroll	Scroll highlighted digit down to 0
04	001000	 2 x	Shift cursor 2 positions left
05	001000		Scroll highlighted digit down to 0
06	000000		Shift cursor left
07	000000	 5 x or scroll	Scroll highlighted digit up to 5
08	050000		Shift cursor left
09	050000	 2 x or scroll	Scroll highlighted digit up to 2
10	250000		Save new setting and return to the parameter number level

6.5. Code Protection against Unauthorized Keypad Access

Parameter group F08 allows to define an own locking code for each of the parameter menus. This permits to limit access to certain parameter groups to specific persons only.

When accessing a protected parameter group, the display will first show “CODE” and wait for your entry. To continue keypad operations, you must now enter the code which you have stored before, otherwise the unit will return to normal operation again.

After entering your code, press the ENTER key and keep it down until the unit responds. When your code was correct, the response will be “YES” and the menu will work normally. With incorrect code the response will be “NO” and the menu remains locked.

6.6. Return from the Programming Levels and Time-Out Function



At any time, the PROG key sets the menu one level up and finally returns to normal operation. The same step occurs automatically via the time-out function, when during a period of 10 seconds no key has been touched.

Termination of the menu by automatic time-out will not store new settings, unless they have already been stored by the PROG key after editing.

6.7. Reset all Parameters to Factory Default Values

Upon special need it may be desirable to set all parameters back to their original factory settings (e.g. because you have forgotten your access code, or by too many change of settings you have achieved a complex parameter state). Default values are indicated in the parameter tables shown later.

To reset the unit to default, please take the following steps:

- **Switch power off**
- Press  and  simultaneously
- **Switch power on while you keep down both keys**



Where you decide to take this action, please note that all parameters and settings will be lost, and that you will need to run a new setup procedure again.

7. Menu Structure and Description of Parameters

All parameters are arranged in a reasonable order of functional groups (F01 to F13) You must only set those parameters which are really relevant for your specific application. Unused parameters can remain as they actually are.

7.1. Summary of the Menu

This section shows a summary of the parameter groups, with an assignment to the functional parts of the unit.

Group	Function	Group	Function
F01	Preselection Settings	F02	Basic Settings
000	Preselection 1	008	Encoder Selection
001	Preselection 2	009	Operational Mode
002	Preselection 3	010	Decimal Point 1
003	Preselection 4	011	Decimal Point 2
004	Preset Value 1 (Encoder 1)	012	Decimal Point {1,2}
005	Preset Value 2 (Encoder 2)	013	Scaling Factor {1.2}
		014	Divider {1,2}
		015	Offset {1,2}
		016	Brightness
		017	Display Update Time
		018	Dual SSI Sync. Mode
F03	SSI Settings Encoder 1	F04	SSI Settings Encoder 2
021	SSI Mode	039	SSI Mode
022	SSI Bit	040	SSI Bit
023	SSI Format	041	SSI Format
024	SSI Baud Rate	042	SSI Baud Rate
025	SSI High Bit	043	SSI High Bit
026	SSI Low Bit	044	SSI Low Bit
027	SSI Zero Definition	045	SSI Zero Definition
028	SSI Set Value	046	SSI Set Value
029	SSI Direction	047	SSI Direction
030	SSI Round Loop	048	SSI Round Loop
031	M-Factor	049	M-Factor
032	D-Factor	050	D-Factor
033	PM-Factor	051	PM-Factor
034	Display Format	052	Display Format
035	SSI Error Bit	053	SSI Error Bit
036	SSI Polarity	054	SSI Polarity

Group	Function
-------	----------

F05	Incremental Encoder Setting
057	Encoder Properties
058	Edge Counting
059	Counting Direction
060	Scaling Factor
061	Multiplier
062	Set Value
063	Round Loop
064	Display Format
065	Power Down Memory

Group	Function
-------	----------

F06	Command Setting
068	Key UP Function
069	Key DOWN Function
070	Key ENTER Function
071	Cont.1 Input Configuration
072	Cont.1 Input Function
073	Cont.2 Input Configuration
074	Cont.2 Input Function
075	Cont.3 Input Configuration
076	Cont.3 Input Function
077	Cont.4 Input Configuration
078	Cont.4 Input Function

F07	Switching Features
-----	--------------------

081	Output Pulse Time 1
082	Output Pulse Time 2
083	Output Pulse Time 3
084	Output Pulse Time 4
085	Hysteresis 1
086	Hysteresis 2
087	Hysteresis 3
088	Hysteresis 4
089	Preselection Mode 1
090	Preselection Mode 2
091	Preselection Mode 3
092	Preselection Mode 4
093	Preset Mode
094	Output Polarity
095	Thumbwheel Sign
096	Thumbwheel Configuration
097	Output Lock
098	Switch Point Calculation

F08	Keypad Setting
-----	----------------

101	Code to access parameter group F1
102	Code to access parameter group F2
103	Code to access parameter group F3
104	Code to access parameter group F4
105	Code to access parameter group F5
106	Code to access parameter group F6
107	Code to access parameter group F7
108	Code to access parameter group F8
109	Code to access parameter group F9
110	Code to access parameter group F10
111	Code to access parameter group F11
112	Code to access parameter group F12
113	Code to access parameter group F13

F09	Analogue Settings
-----	-------------------

118	Analogue Format
119	Analogue Start
120	Analogue End
121	Analogue Output Swing
122	Analogue Offset
123	Analogue Output Assignment

Group	Function
F10	Serial Communication
125	Unit Number
126	Serial Baud Rate
127	Serial Format
128	Serial Protocol
129	Serial Timer
130	Register Code

Group	Function
F11	Linearization General Settings
135	Linearization Mode Encoder 1
136	Linearization Mode Encoder 2

Group	Function
F12	Linearization Points Encoder 1
139	First point (x1, original value)
140	First point (y1, replacement for x1)
	etc. ----->
169	Last point (x16, original value)
170	Last point (y16, replacement for x16)

Group	Function
F13	Linearization Points Encoder 2
171	First point (x1, original value)
172	First point (y1, replacement for x1)
	etc. ----->
201	Last point (x16, original value)
202	Last point (y16, replacement for x16)

7.2. Functional Overview of the Parameter groups

The following schematics shows how in principle the parameter blocks are assigned to the various elements and functions of the SSI indicator.

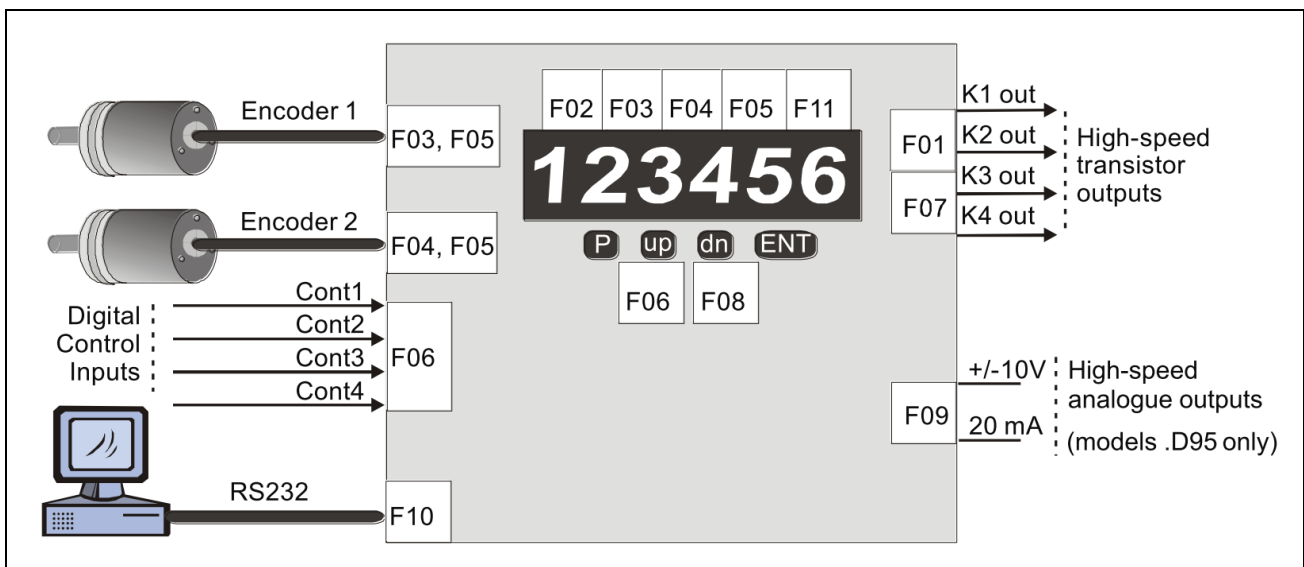

7.3. Important Hints



The following tables contain parameters which are **highlighted by yellow color**. This indicates that the number of digits of this parameter depends on the model in use (i.e. 6 decades with models 6.575.0116. and 8 decades with models 6.575.0118).

The column "Default" of each table shows the factory default setting of the parameter.

The column "Ser." of each table indicates the serial access code of the parameter.



Possible Cause of Risk of Damage of the Unit or the Encoders

- The present indicator units provide options to connect encoders with either Synchronous Serial Interface (SSI) or Incremental Encoders with differential 5V-TTL outputs. Depending on the particular choice of encoders the parameters of the groups F03, F04 and F05 are used to configure the encoder screw terminals as either inputs or outputs.
- When the settings of the relevant parameters do not match with the types of encoders effectively connected to the unit, under unfavorable circumstances the unit or one of the encoders might be damaged.
- For prevention of possible damage, ex factory all units are shipped with a default setting of parameter F02.008 [Encoder Selection] = [5]. This means that all encoder lines are initially in a neutral and deactivated state. Please make first sure that all parameters of group F03 (SSI-Encoder 1) and if necessary, groups F04 (SSI-Encoder 2) and F05 (Incremental Encoder) have been set correctly and in accord with the encoders in use, then change [Encoder Selection] to the correct value
- To avoid damage by accidental misadjustment it is recommended to have the encoders disconnected whenever parameter F02.008 must be changed,

7.4. Detailed Description of Parameters

7.4.1. Preselection Settings

F01	Parameter	Range	Default	Ser.
000	Preselection 1: switching threshold for output K1	-199 999 ... 999 999	1 000	00
001	Preselection 2: switching threshold for output K2	-199 999 ... 999 999	2 000	01
002	Preselection 3: switching threshold for output K3	-199 999 ... 999 999	3 000	02
003	Preselection 4: switching threshold for output K4	-199 999 ... 999 999	4 000	03
004	Set Value 1: preset of encoder channel 1 An internal or external set command will set encoder 1 to this value, provided that parameter F07.093 [Preset Mode] has been set to [1]. See hint under 8.3.	-199 999 ... 999 999	0	04
005	Set Value 2: preset of encoder channel 2 An internal or external set command will set encoder 2 to this value, provided that parameter F07.093 [Preset Mode] has been set to [1]. See hint under 8.3.	-199 999 ... 999 999	0	05

7.4.2. Basic Settings

F02	Parameter	Range	Default	Ser.
008	Encoder Selection: type and evaluation of encoders 0 = one SSI encoder only (encoder input 1, <u>single-read</u>) 1 = one SSI encoder only (encoder input 1, <u>double-read</u>) 2 = two SSI encoders (encoder inputs 1 and 2) 3 = encoder 1 = SSI, encoder 2 = incremental 4 = not available 5 = neutral setting, all encoder inputs are deactivated (see warning under 7.3)	0 - 5	5	A0
009	Operational Mode: evaluation of the encoders 0 = independent evaluation of encoder 1 and encoder 2 1 = summation mode [encoder 1] + [encoder 2] 2 = differential mode [encoder 1] - [encoder 2]	0 - 2	0	A1
010	Decimal Point 1: number of decimal positions for display of encoder 1	0 - 5	0	A2
011	Decimal Point 2: number of decimal positions for display of encoder 2	0 - 5	0	A3
012	Decimal Point 12: number of decimal positions for display of combinations [encoder 1] ± [encoder 2]	0 - 5	0	A4
013	Scaling Factor 12: *) proportional factor for final scaling of the result of [encoder 1] ± [encoder 2]	0.0001 - 9.9999	1.0000	A5
014	Divider 12: *) reciprocal factor for final scaling of the result of [encoder 1] ± [encoder 2]	0.0000 - 9.9999	1.0000	A6
015	Offset 12 *) adding constant for final scaling of the result of [encoder 1] ± [encoder 2]	-199 999 - +999 999	0	A7

*) Details about scaling are described in chapter 8.3

F02	Parameter	Range	Default	Ser.
016	Brightness: brightness of the 7-segment LED display	0 ... 4	0	A8
	0 = 100% of maximum brightness			
	1 = 80% of maximum brightness			
	2 = 60% of maximum brightness			
	3 = 40% of maximum brightness			
4 = ..20% of maximum brightness				
017	Display Update Time:	0.005 - 9.999	0.005	A9
	update time of the LED display (sec.)			
018	Dual SSI Sync Mode: synchronization of SSI encoders	0, 1	0	B0
	0 = SSI telegrams of encoders 1 and 2 are not synchronized			
	1 = SSI telegrams of encoders 1 and 2 are synchronized *)			

*) only expedient when two SSI encoders are operated in Master mode

7.4.3. SSI-Encoder 1 Settings

F03	Parameter	Range	Default	Ser.
021	SSI-Mode: 0 = Slave operation: encoder 1 is clocked by remote Master 1 = Master operation: encoder 1 is clocked by the unit	0, 1	0	B3
022	SSI Bit: encoder resolution (total number of encoder bits)	8 - 32	25	B4
023	SSI Format: data format of the SSI telegrams 0 = data are transmitted with binary code 1 = data are transmitted with Gray code	0, 1	1	B5
024	SSI Baud Rate: clock frequency of SSI telegrams (MHz)	0.100 - 1.000	0.100	B6
025	SSI High Bit: bit masking, highest bit for evaluation *)	1 - 32	25	B7
026	SSI Low Bit: bit masking, lowest bit for evaluation *)	1 - 31	1	B8
027	SSI Zero Value: virtual zero position of the SSI encoder **)	-199 999 - +999 999	0	B9
028	SSI Set Value: **) encoder 1 will be set to this datum by internal or remote command, provided that parameter F07.093 (Preset Mode) has been set to 0 (see clarification under 7.3)	-199 999 - +999 999	0	C0
029	SSI Direction: definition of forward/reverse direction (especially with round-loop operation)	0, 1	0	C1
030	SSI Round Loop: number of steps for one round-loop cycle	0 - 999 999	0	C2
031	M-Factor: **) proportional factor for scaling of the SSI data from encoder 1 (see also 7.3)	-9.999 – 9.999	1.000	C3
032	D-Factor: **) reciprocal factor for scaling of the SSI data from encoder 1 (see also 7.3)	0.001 – 9.999	1.000	C4
033	PM-Factor: **) adding constant for scaling of the SSI data from encoder 1 (see also 7.3)	-199 999 - +999 999	0	C5
034	Display Format: 0 = decimal indication format -199 999 ... 999 999 1 = angular display format 0 - 359.59 (degrees / minutes) 2 = angular format -179.59 - 179.59 (degrees / minutes)	0, 1, 2	0	C6
035	SSI Error Bit: location of the error bit (0 = no error bit)	0 - 32	0	C7
036	SSI Error Polarity: 0 = error bit is HIGH in case of error 1 = error bit is LOW in case of error	0, 1	0	C8

*) full details about bit masking are explained in chapter 8.2

**) full details about scaling are explained in chapter 8.3

7.4.4. SSI-Encoder 2 Settings (if applicable)

F04	Parameter	Range	Default	Ser.
039	SSI-Mode: 0 = Slave operation: encoder 2 is clocked by remote Master 1 = Master operation: encoder 2 is clocked by the unit	0, 1	0	D1
040	SSI Bit: encoder resolution (total number of encoder bits)	8 - 32	25	D2
041	SSI Format: data format of the SSI telegrams 0 = data are transmitted with binary code 1 = data are transmitted with Gray code	0, 1	1	D3
042	SSI Baud Rate: clock frequency of SSI telegrams (MHz)	0.100 - 1.000	0.100	D4
043	SSI High Bit: bit masking, highest bit for evaluation *)	1 - 32	25	D5
044	SSI Low Bit: bit masking, lowest bit for evaluation *)	1 - 31	1	D6
045	SSI Zero Value: virtual zero position of the SSI encoder **)	-199 999 - +999 999	0	D7
046	SSI Set Value: **) encoder 2 will be set to this datum by internal or remote command, provided that parameter F07.093 (Preset Mode) has been set to 0 (see clarification under 8.3)	-199 999 - +999 999	0	D8
047	SSI Direction: definition of forward/reverse direction (Especially with round-loop operation)	0, 1	0	D9
048	SSI Round Loop: number of steps for one round-loop cycle	0 - 999 999	0	E0
049	M-Factor: **) proportional factor for scaling of the SSI data from encoder 2 (see also 8.3)	-9.999 - 9.999	1.000	E1
050	D-Factor: **) reciprocal factor for scaling of the SSI data from encoder 2 (see also 8.3)	0.001 - 9.999	1.000	E2
051	PM-Factor: **) adding constant for scaling of the SSI data from encoder 2 (see also 8.3)	-199 999 - +999 999	0	E3
052	Display Format: 0 = decimal indication format -199 999 ... 999 999 1 = angular display format 0 - 359.59 (degrees / minutes) 2 = angular format -179.59 - 179.59 (degrees / minutes)	0, 1, 2	0	E4
053	SSI Error Bit: location of the error bit (0 = no error bit)	0 - 32	0	E5
054	SSI Error Polarity: 0 = error bit is HIGH in case of error 1 = error bit is LOW in case of error	0, 1	0	E6

*) full details about bit masking are explained in chapter 8.2

**) full details about scaling are explained in chapter 8.3

7.4.5. Inc Encoder Settings (if an incremental encoder is in use)

F05	Parameter	Range	Default	Ser.
057	Encoder Properties: 0 = signals A, /A = impulse, B, /B = static direction 1 = signals A, /A and B, /B are quadrature (2 x 90°)	0, 1 *)	1	E9
058	Edge Counting: evaluation of edges 0 = single evaluation only (rising edge of A) (x1) 1 = double evaluation (rising and falling edge of A) (x2) 2 = quad evaluation (all edges A and B) (x4)	0 ... 2	0	F0
059	Counting Direction: up or down 0 = counts up when A leads B 1 = counts down when A leads B	0 ... 1	0	F1
060	Scaling Factor: impulse scaling multiplier for all counted input edges	0.00001 ... 9.99999	1.00000	F2
061	Multiplier: Integer impulse multiplier multiple count of each input edge	001 ... 999	001	F3
062	Set Value: the incremental counter will be set to this datum by internal or remote command, provided that parameter F07.093 (Preset Mode) has been set to 0 (see clarification under 8.3)	-199 999 bis 999 999	0	F4
063	Round-Loop: Counting cycle with round-loop operation 0 = unlimited counting xxx counter loops in cycles from 0 to xxx	0 ... 999 999	0	F5
064	Display Format: 0 = decimal indication format -199 999 ... 999 999 1 = angular display format 0 - 359.59 (degrees / minutes) 2 = angular format -179.59 - 179.59 (degrees / minutes)	0 - 2	0	F6
065	Power Down Memory: behavior after power down 0 = memory OFF, counter restarts always 0 1 = memory ON, counter restarts with it's last result	0, 1	0	F7

*) Only incremental encoders with differential outputs A, /A, B /B at 5 volts TTL level can be used.

7.4.6. Command Settings (Assignment of Commands to Inputs and Keys)

F06	Parameter	Range	Default	Ser.
068	Key UP Function (supplementary function of the key „UP“) <hr/> 0 = no key function 1 = Reset encoder channel 1 *) 2 = Reset encoder channel 2 *) 3 = Reset encoder channels 1 and 2 *) 4 = Inhibit encoder channel 1 (disable count) 5 = Inhibit encoder channel 2 (disable count) 6 = Inhibit encoder channels 1 and 2 (disable count) 7 = Ignore Offset / Set (display real value without offset) 8 = n.a. 9 = Trigger serial data transmission *) 10 = Reset minimum / maximum memories to the actual value *) 11 = Scroll the value shown in display *) 12 = n.a.	0 ... 11	0	G0
069	Key DOWN Function (supplementary function of the key „DOWN“) see key „UP“	0 ... 12	0	G1
070	Key ENTER Function (supplementary function of the key „ENTER“) see key „UP“	0 ... 12	0	G2

*) Edge triggered command

F06	(continued)	Range	Default	Ser.
071	Input 1 Configuration: (switching characteristics of input „Cont.1“) 0 = NPN (switch to –), Function active LOW 1 = NPN (switch to –), Function active HIGH 2 = NPN (switch to –), rising edge 3 = NPN (switch to –), falling edge 4 = PNP (switch to +), Function active LOW 5 = PNP (switch to +), Function active HIGH 6 = PNP (switch to +), rising edge 7 = PNP (switch to +), falling edge	0 ... 7	0	G3
072	Input 1 Function: function assignment to input „Cont.1“ 0 = no input function 1 = Reset encoder channel 1 *) 2 = Reset encoder channel 2 *) 3 = Reset encoder channels 1 and 2 *) 4 = Inhibit encoder channel 1 (disable count) 5 = Inhibit encoder channel 2 (disable count) 6 = Inhibit encoder channels 1 and 2 (disable count) 7 = Ignore Offset / Set (display real value without offset) 8 = n.a. 9 = Trigger serial data transmission *) 10 = Reset minimum / maximum memories to the actual value *) 11 = Scroll the value shown in display *) 12 = Keyboard Lock (hardware disable for the keypad)	0 ... 12	0	G4
073	Input 2 Configuration: (switching characteristics of input „Cont.2“) See „Cont.1“ (F06.071)	0 ... 7	0	G5
074	Input 2 Function: function assignment to input „Cont.2“ See „Cont.1“ (F06.072)	0 ... 12	0	G6
075	Input 3 Configuration: (switching characteristics of input „Cont.3“) See „Cont.1“ (F06.071)	0 ... 7	0	G7
076	Input 3 Function: function assignment to input „Cont.3“ See „Cont.1“ (F06.072)	0 ... 12	0	G8
077	Input 4 Configuration: (switching characteristics of input „Cont.4“) 0 = NPN (switch to –), Function active LOW 1 = NPN (switch to –), Function active HIGH 2 = PNP (switch to +), Function active LOW 3 = PNP (switch to +), Function active HIGH	0 ... 3	0	G9
078	Input 4 Function: function assignment to input „Cont.4“ See „Cont.1“ (F06.072)	0 ... 12	0	H0



Open (unconnected) NPN inputs are always in HIGH state (internal pull-up resistor)
Open (unconnected) PNP inputs are always in LOW state (internal pull-down resistor)

*) Edge triggered command

7.4.7. Switching Features (switching characteristics of outputs K1 - K4)

F07	Parameter	Range	Default	Ser.
081	Output pulse time (sec.) output K1	0.00 ... 9.99 (0 = static operation)	0.00	H3
082	Output pulse time (sec.) output K1			
083	Output pulse time (sec.) output K1			
084	Output pulse time (sec.) output K1			
085	Switching hysteresis K1 (display units) *)	0 - 9999	0	H7
086	Switching hysteresis K2 (display units) *)			
087	Switching hysteresis K3 (display units) *)			
088	Switching hysteresis K4 (display units) *)			
089	Preselection Mode 1 (switching definition preselection 1) 0 = switch ON when actual value \geq preselection 1 1 = switch ON when actual value \leq preselection 1 2 = output represents the error bit of SSI encoder 1 3 = output represents the error bit of SSI encoder 2	0 - 3	0	I1
090	Preselection Mode 2 (see above, but preselection 2)			
091	Preselection Mode 3 (see above, but preselection 3)			
092	Preselection Mode 4 (see above, but preselection 4)			
093	Preset Mode (source of the set value) 0 = A Set command will set encoder channel 1 to the value of [Preset Value 1] (F03.028) and encoder channel 2 to the value of [Preset Value 2] (F04.046) With incremental operation the counter will be set to the value of [Set Value] (F05.062). 1 = A Set command will set encoder channel 1 to the value of [Set Value 1] (F01.004) and encoder channel 2 to the value of [Set Value 2] (F01.005).	0, 1	0	I5

*) The switching point equals to the preset value and the return point is displaced by the hysteresis setting

F07	(continued)	Range	Default	Ser.
094	Output Polarity (closing or opening contact) K1= 4 bit binary setting: bit with binary value 1 K2= 4 bit binary setting: bit with binary value 2 K3= 4 bit binary setting: bit with binary value 4 K4= 4 bit binary setting: bit with binary value 8 Bit = 0: passive state = OFF, active state = ON (N.O. *) Bit = 1: passive state = ON, active state = OFF (N.C. *)	0 - 15 Example: Setting "9" (1-0-0-1) means: K1 and K4 operate N.C. and K2 and K3 operate N.O. *)	0	I6
095	n.a.	see appendix 0 - 15	0	I7
096	n.a.	see appendix 0 - 23	0	I8
097	Output Lock (suppression of timed output switching upon power-up)	0 = suppression OFF 1 = suppression ON	0	I9
098	Switch Point Calculation (switch point calculation with trailing preselections) 0: K1=>K1, K2=>K2, K3=>K3, K4=>K4 1: K1=>K1, <u>K1-K2</u> =>K2, K3=>K3, K4=>K4 2: K1=>K1, K2=>K2, K3=>K3, <u>K3-K4</u> =>K4 3: K1=>K1, <u>K1-K2</u> =>K2, K3=>K3, <u>K3-K4</u> =>K4 Example: if set to "1", K1, K3 and K4 switch normally but the K2 switching point would be substituted by the difference K1 - K2 (i.e. F00.000 - F00.001)	0 - 3	0	J0

7.4.8. Keypad Setting (Access codes for the various parameter groups)

F08	Parameter	Range	Default	Ser.
101	Protection code for group F01 (Preselection Settings)	0 – 999 999 0 = accessible without code 1 – 999 999 = individual access code of the actual parameter group	0	J3
102	Protection code for group F02 (Basic Settings)		0	J4
103	Protection code for group F03 (SSI Settings Encoder 1)		0	J5
104	Protection code for group F04 (SSI Settings Encoder 2)		0	J6
105	Protection code for group F05 (Incremental Encoder Settings)		0	J7
106	Protection code for group F06 (Command Settings)		0	J8
107	Protection code for group F07 (Switching Features)		0	J9
108	Protection code for group F08 (Keypad Settings)		0	K0
109	Protection code for group F09 (Analogue Settings)		0	K1
110	Protection code for group F10 (Ser. Communication Settings)		0	K2
111	Protection code for group F11 (Linearization General Settings)		0	K3
112	Protection code for group F12 (Linearization Points Encoder 1)		0	K4
113	Protection code for group F13 (Linearization Points Encoder 2)		0	K5

7.4.9. Analogue Settings (Scaling of the analogue output with models IA)

F09	Parameter	Range	Default	Ser.
118	Output format: 0= Voltage – 10 V... + 10 V 1= Voltage 0 +10 V 2= Current 4 – 20 mA 3= Current 0 – 20 mA	0 ... 3	0	L0
119	Analogue Start: Beginning of the conversion range Display value to generate 0 volts or 0/4 mA	-199999 – 999 999	0	L1
120	Analogue End: end of the conversion range Display value to generate 10 volts or 20 mA	-199999 – 999 999	10 000	L2
121	Analogue Swing: (output swing, 1000 = 10 V or 20 mA)	0 ... 1000	1000	L3
122	Analogue Offset: (mV, zero displacement of the output)	-10000 - 10000	0	L4
123	Analogue Assignment: (source of the output signal) (according to lines 1 – 5 of the display scrolling function)	0 5 (line1) ... (line6)	0	L5

- *) Example:
when you use the summing application according to chapter 4.4, but your analogue output should follow to encoder 1 only, then assign the analogue output to line 4, e.g. set this parameter to "3".

7.4.10. Serial Settings (serial communication setup)

F10	Parameter	Range	Default	Ser.
125	Unit Number: serial device address	11 ... 99	11	90
126	Serial Baud Rate: transmission speed 0 = 9600 Bauds 1 = 4800 Bauds 2 = 2400 Bauds 3 = 1200 Bauds 4 = 600 Bauds 5 = 19200 Bauds 6 = 38400 Bauds	0 ... 6	0	91
127	Serial Format: data and parity format 0 = 7 Data, Parity even, 1 Stop 1 = 7 Data, Parity even, 2 Stop 2 = 7 Data, Parity odd, 1 Stop 3 = 7 Data, Parity odd, 2 Stop 4 = 7 Data, no Parity, 1 Stop 5 = 7 Data, no Parity, 2 Stop 6 = 8 Data, Parity even, 1 Stop 7 = 8 Data, Parity odd, 1 Stop 8 = 8 Data, no Parity, 1 Stop 9 = 8 Data, no Parity, 2 Stop	0 ... 9	0	92
128	Serial Protocol: transmit protocol for printer mode *) 0 = Transmission = Unit Nr. – Data, LF, CR 1 = Transmission = Data, LF, CR	0 ... 1	0	L7
129	Serial Timer: timer for timed transmissions (sec.) *)	0.000 ... 99.999	0	L8
130	Register Code: serial code of the transmit value *)	0 ... 19	0	L9

*) For details about serial communication please refer to chapter 9.

7.4.11. Linearization Settings (Basic settings for Linearization)

F11	Parameter	Range	Default	Ser.
135	Linearization Mode Ch.1: mode for encoder 1	0 – 2	0	M4
	0 = Linearization is OFF	(see drawings on next page)		
	1 = Linearisation is defined for the numeric range from 0 to +999 999 only and negative values will appear as a mirror of the positive values			
	2 = Linearisation is defined over the full range from -199 999 to +999 999			
136	Linearization Mode Ch.2: mode for encoder 2	0 – 2	0	M5
	0 = Linearization is OFF	(see drawings on next page)		
	1 = Linearisation is defined for the numeric range from 0 to +999 999 only and negative values will appear as a mirror of the positive values			
	2 = Linearisation is defined over the full range from -199 999 to +999 999			

7.4.12. Linearization Channel 1 (Table of interpolation points)

F12	Parameter	Range	Default	Ser.
139	First interpolation point, (x0, original value)	-199999 - 999999	0	M8
140	First interpolation point, (y0, replacement value)			M9
141	Second interpolation point (x1, original value)			N0
142	Second interpolation point (y1, replacement value)			N1
	etc. ---->			
169	Last interpolation point, (x15, original value)			P8
170	Last interpolation point, (y15, replacement value)			P9

7.4.13. Linearization Channel 2 (Table of interpolation points)

F13	Parameter	Range	Default	Ser.
171	First interpolation point, (x0, original value)	-199 999 - 999999	0	Q0
172	First interpolation point, (y0, replacement value)			Q1
173	Second interpolation point (x1, original value)			Q2
174	Second interpolation point (y1, replacement value)			Q3
	etc. ---->			
201	Last interpolation point, (x15, original value)			T0
202	Last interpolation point, (y15, replacement value)			T1

8. Hints for Use of the SSI Indicator

8.1. Master- und Slave-Betrieb (with use of SSI encoders)

Each of the two encoder inputs can be individually set to either "Master" operation or "Slave" operation (parameters F03.021 and F04.039). With "Master" mode it is the SSI indicator that generates the SSI clock for the encoder. Therefore, in this case the Clock terminals (CLK) are automatically configured as outputs.

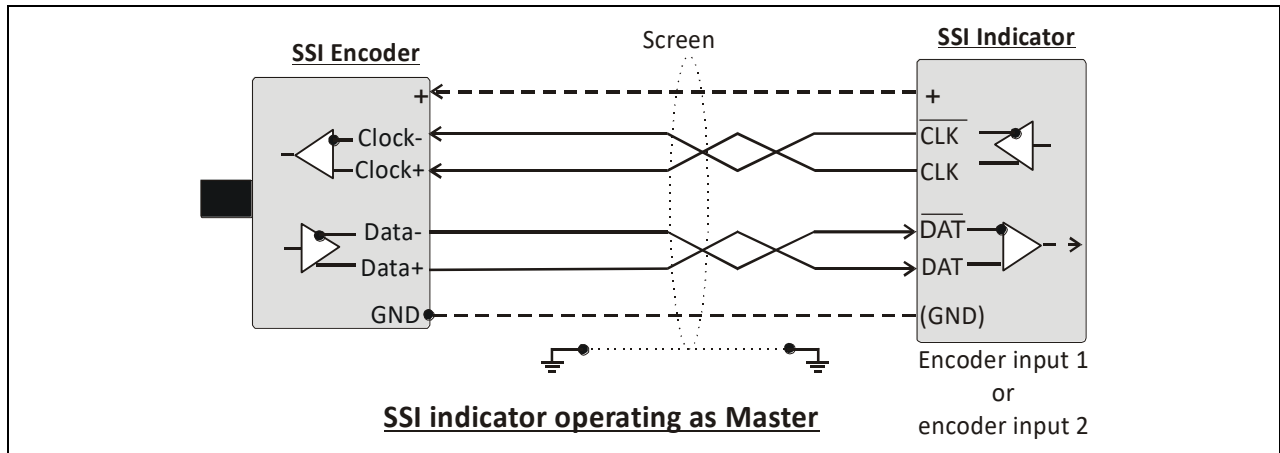

When the encoder already receives its clock from a remote unit and the SSI indicator should only "listen" to the communication, the corresponding encoder input must be configured as "Slave". In this case the clock terminals (CLK) of the indicator are configured as inputs.

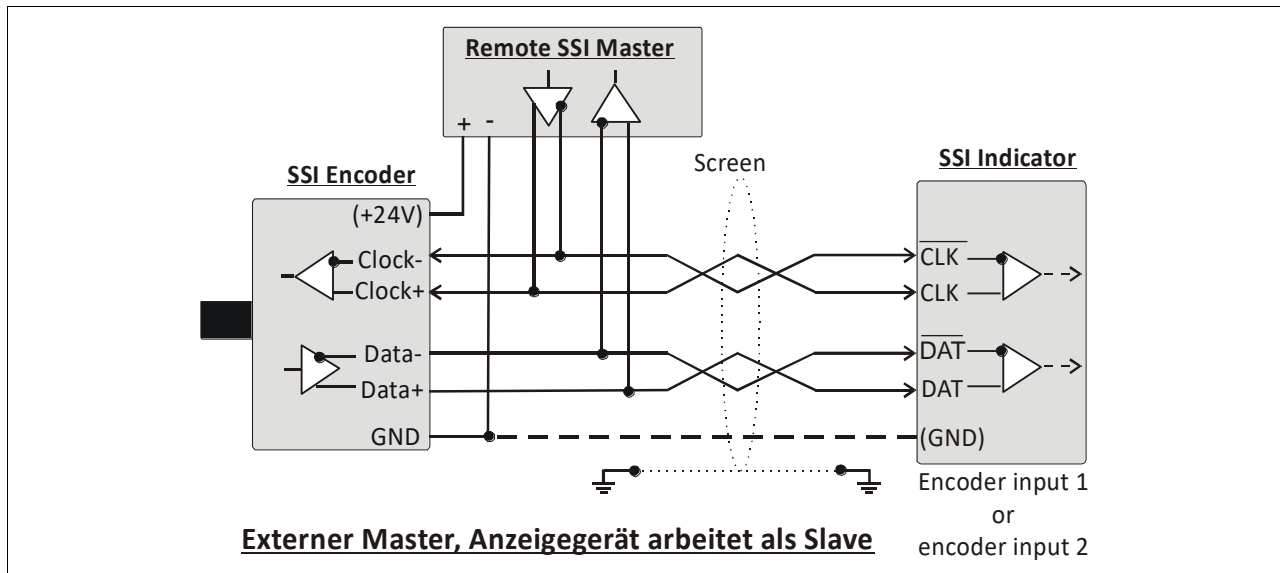

It is mandatory to set the proper Baud rate also with Slave operation. In this case the setting serves to determine the pause time for correct synchronization (SSI pause is detected after 4 clock cycles).

8.2. Bit Evaluation (with use of SSI encoders)

This chapter explains the correlation between the setting of the total number of encoder bits (F03.022 and F04.040) and the attached bit masking parameters "SSI High Bit" and "SSI Low Bit". All subsequent explanations are based on an example encoder with 16 bits.



- Unused Bits may be blanked out according to individual need
- Whenever the number of bits (clock cycles) requested from the SSI Master is higher than the real number of encoder bits, all excessive Bits must be blanked by corresponding setting of parameters „Hi_bit“ and „Lo_bit“.

Basic Settings:

In general parameter „SSI Bit“ will always be set according to the real resolution of the encoder (i.e. setting 16 with the 16 bit example encoder). In this normal case the SSI telegram will not contain any excessive bits.

With some applications (e.g. with Slave operation) it may however happen that the Master transmits more clock cycles than the number of encoder bits (e.g. 21 clocks with a 16 bit encoder). In such a case the master would always request 21 bits from the encoder, where the encoder itself responds with 16 usable bits only, followed by 5 waste bits. These 5 excessive bits must be blanked.

All standard SSI telegrams start with the most significant bit (MSB) and close with the least significant bit (LSB). Unusable waste bits (X) will follow at the tail end. To blank these bits out, in our example we would have to set „Hi bit“ to 21 and „Lo bit“ to 6 for proper evaluation of the encoder information.

	Hi Bit ↓															Lo Bit ↓					
Requested bits (Master)	21	20	19	18	17	16	15	14	13	12	11	10	9	8	7	6	5	4	3	2	1
Usable bits (encoder)	16	15	14	13	12	11	10	9	8	7	6	5	4	3	2	1	X	X	X	X	X

8.3. Scaling of the SSI Indicator

The following formulae explain how the unit calculates the display value from the encoder data and the scaling parameters:

8.3.1. Encoder 1 = SSI

$$\text{Display1} = [(\text{SSI data encoder1}) - (\text{SSI Zero Value}) + (\text{SSI Set Value})] \times [(\text{M-Factor}) : (\text{D-Factor})] + [(\text{PM-Factor})]$$

(F03.027) (F03.028) (F03.031) (F03.032) (F03.033)
(or F01.004*)

8.3.2. Encoder 2 = SSI

$$\text{Display2} = [(\text{SSI data encoder2}) - (\text{SSI Zero Value}) + (\text{SSI Set Value})] \times [(\text{M-Factor}) : (\text{D-Factor})] + [(\text{PM-Factor})]$$

(F04.045) (F04.046) (F04.049) (F04.050) (F04.051)
(or F01.005*)

8.3.3. Encoder 2 = incremental

$$\text{Display (1 or 2)} = [(\text{impulse count}) \times (\text{Multiplier}) \times (\text{Scaling Factor})]$$

(F05.061) (F05.060)

8.3.4. Summation or Differential Evaluation of two Encoders

$$\text{Total Display} = [\text{display1} \pm \text{display2}] \times [(\text{Scaling Factor12}) : (\text{Divider12})] + [(\text{Offset12})]$$

(F02.013) (F02.014).....(F02.015)



- Operation with angular display modes 359.59° or ±180.00° will automatically deactivate the scaling parameters "M-Factor", "D-Factor" and "PM-Factor". Parameter "SSI-Direction" remains still active.
- Operation with use of the Linearization function will automatically deactivate the scaling parameters "M-Factor", "D-Factor", "PM-Factor" and also "SSI Direction".

*) When your application requires a frequent change of the set value, it is advisable to set parameter "Preset Mode" (F07.093) to 1. Encoder input 1 then will source its numeric set value from location F01.004 (Set Value 1) and encoder input 2 from location F01.005 (Set Value 2). These two parameter locations are accessible via the "Fast Access Procedure" of the keypad which allows easier and faster changes.



- Every Reset command (keypad or control input) will automatically overwrite the register [SSI Zero Value] by the actual SSI position of the encoder. When parameter (SSI Set Value) is set to zero, the Reset command will therefore set the whole contents of the brackets to zero and the unit will hence indicate the numeric value of [PM-Factor]. This new definition of the zero point will be memorized and remain valid even after power down of the unit.
- SSI data transmitted by the encoder are always positive only. Where you like to display also negative values, this can be achieved by corresponding settings of the parameters [SSI Set Value] or [P-Factor].
- The LED display provides 6 resp. 8 decades. For this reason, all parameter settings including [SSI Set Value] are also limited to a maximum range of 6 resp. 9 decades. SSI encoders with a resolution of more than 19 bits will however generate SSI data with more than 6 decades and encoders with more than 26 bit will even exceed the 8 decade range. It may therefore become most difficult to set proper scaling parameters while the mechanical encoder position is outside of the regular display range (the unit would insistently display "overflow").
To avoid this problem, it is advisable to limit the evaluation range to maximum 19 resp. 26 bits with use of the bit blanking function.
- Where you intend to use the „Round-Loop" function as described subsequently, it is even mandatory to blank all out-of-range bits.

8.4. Basic Operation Modes of the Indicator

8.4.1. Normal SSI display

Normal operation provides calculation of the display value from the SSI encoder data and the settings of the scaling factors. Negative values can be achieved by corresponding setting of the zero-position, or by inversion of the direction bit.

To set the unit up without problem, it is best to use the following sequence of steps:

- Set all basic parameters according to the encoder type you use (parameter groups F02, F03, F04)
- For better comprehension, use first all initial settings as shown in the list (xxx = according to need)

Encoder Selection	:	0 or 2	SSI Direction	:	0
Operational Mode	:	0	SSI Round-Loop	:	0
Decimal Point (all)	:	0	M-Factor	:	1.0000
Dual SSI Sync Mode		0	D-Factor	:	1.0000
High Bit	:	see 8.2 *)	PM-Factor	:	0
Low Bit	:		Display Format	:	0
SSI Zero Value	:	0			
SSI Set Value	:	0			

*) Evaluate max. 19 bits (6 decade units) or 26 bits (8 decade units) to avoid scaling problems

These settings ensure that the unit displays the pure SSI encoder information at first.

- Move your encoder now from a “lower” position towards a “higher” position according to your own definition of "low" and "high". When also the display changes from lower to higher values, your own definition of directions matches with the encoder definition. If not, change the setting of “Direction” from “0” to “1” now to receive the desired sense of direction (changes after further parameter settings may cause different results)
- Set the desired zero position, either by entering the numeric value to [SSI Zero Value] or by using the Reset function as described previously. Your zero definition will divide the range into a positive and a negative zone.
- At this time, you are free to set all other registers according to your needs.

The following diagrams explain the behavior of the indicator using an example with a 13 bit single-turn SSI encoder, where [SSI Direction] is set to [0] (upper diagram) and to [1] (lower diagram) while [SSI Zero Value] is always set to [1024].

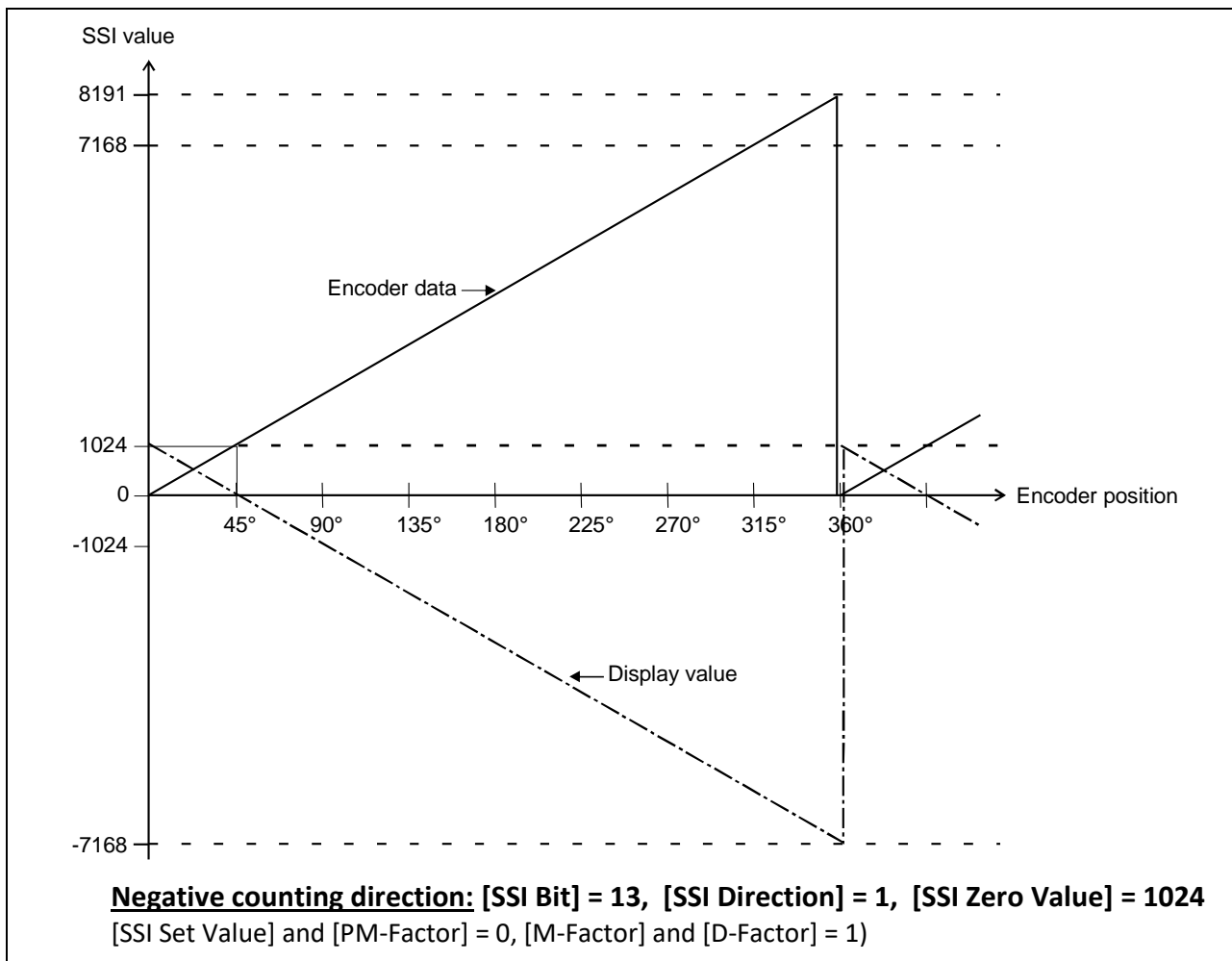
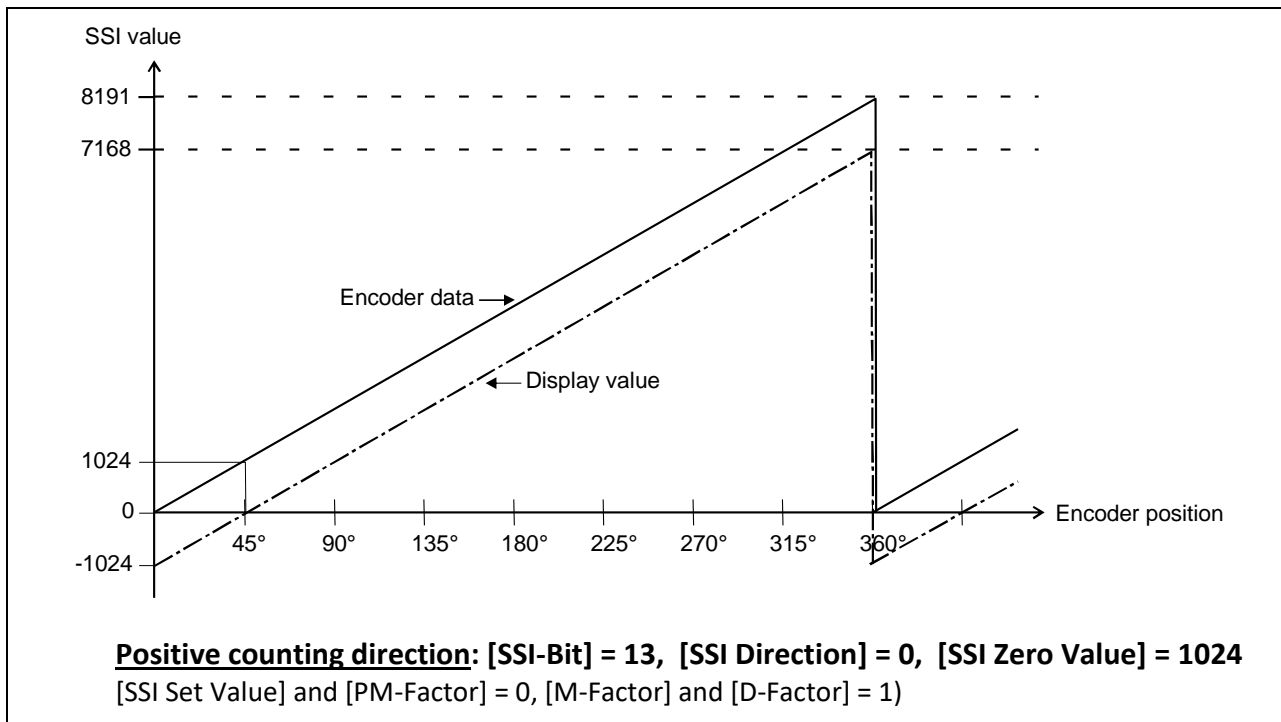

8.4.2. Round-Loop Function

This mode of operation is used frequently with rotating round tables or similar applications, where the absolute encoder information is only used for a limited and repeating range of the encoder (like one revolution of the table, which must not at the same time mean one revolution of the encoder shaft). The Round-Loop Function will not generate any negative display values, unless parameter [PM Factor] has been set to a negative offset value.

The Round-Loop Function allows assigning a programmable number of encoder steps to one full 360° rotation of the table. To avoid miscounting when passing the mechanical overflow of the encoder range, the total encoder resolution should be an integer multiple of the number of steps for one loop.

For setup, please proceed first like shown under section 8.4.1.

Then set register [SSI Round Loop] to the number of steps corresponding to one revolution of the table. [SSI Direction] provides selection of the sense of rotation. You are free to scale the display to any engineering units desired, by setting the scaling factors correspondingly.

Where you like to read your display with angular format (359°59'), please modify parameter [Display Format] from setting "0" to either "1" or "2". This will also automatically disable the general scaling factors.

The subsequent diagram shows the round loop function with a 13 bit encoder, where one table revolution corresponds to 4096 encoder steps and where the zero position has been displaced by 1024 encoder steps.

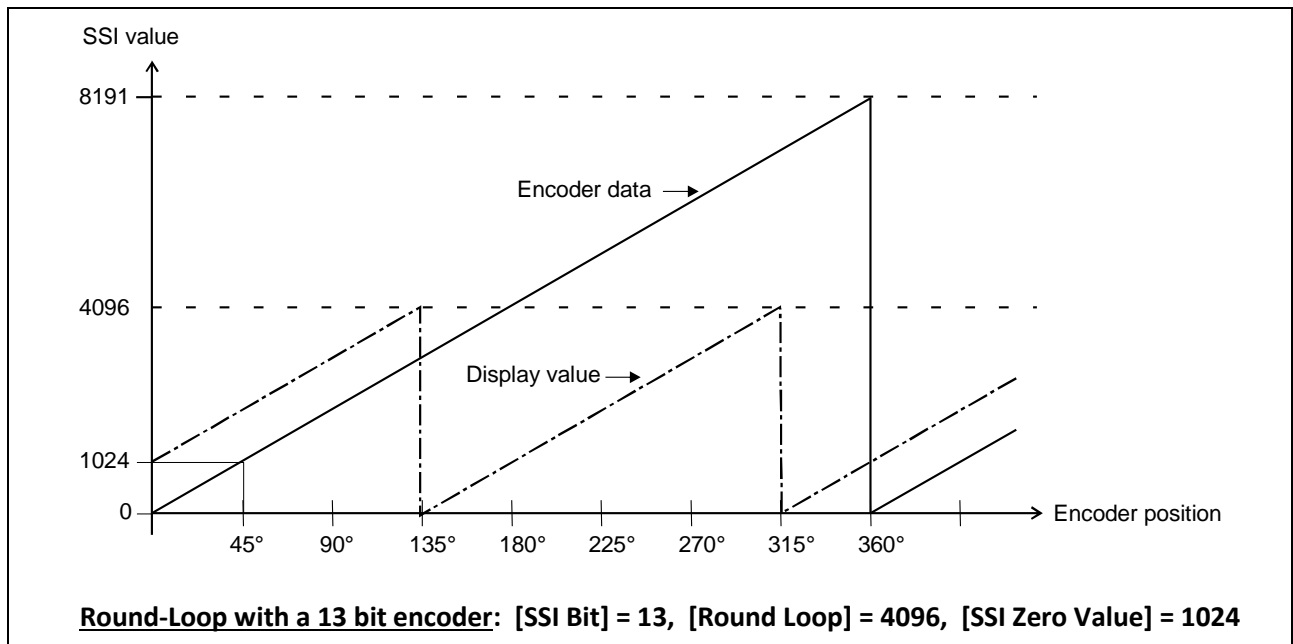

8.4.3. Displacement of the mechanical zero position of the encoder

Many times, it is difficult to mount the encoder in a specific mechanical position. Therefore, it may occur that the encoder overflow position is located right inside the working range of the encoder. When this is not acceptable, the Round Loop Function also allows to shift the overflow position to any location outside your working range. To do this, set [Round Loop] to the total number of steps according to the encoder resolution, then shift the overflow position to an acceptable location outside your range, by corresponding setting of [SSI Zero Value] (numerical parameter setting or remote Reset command).

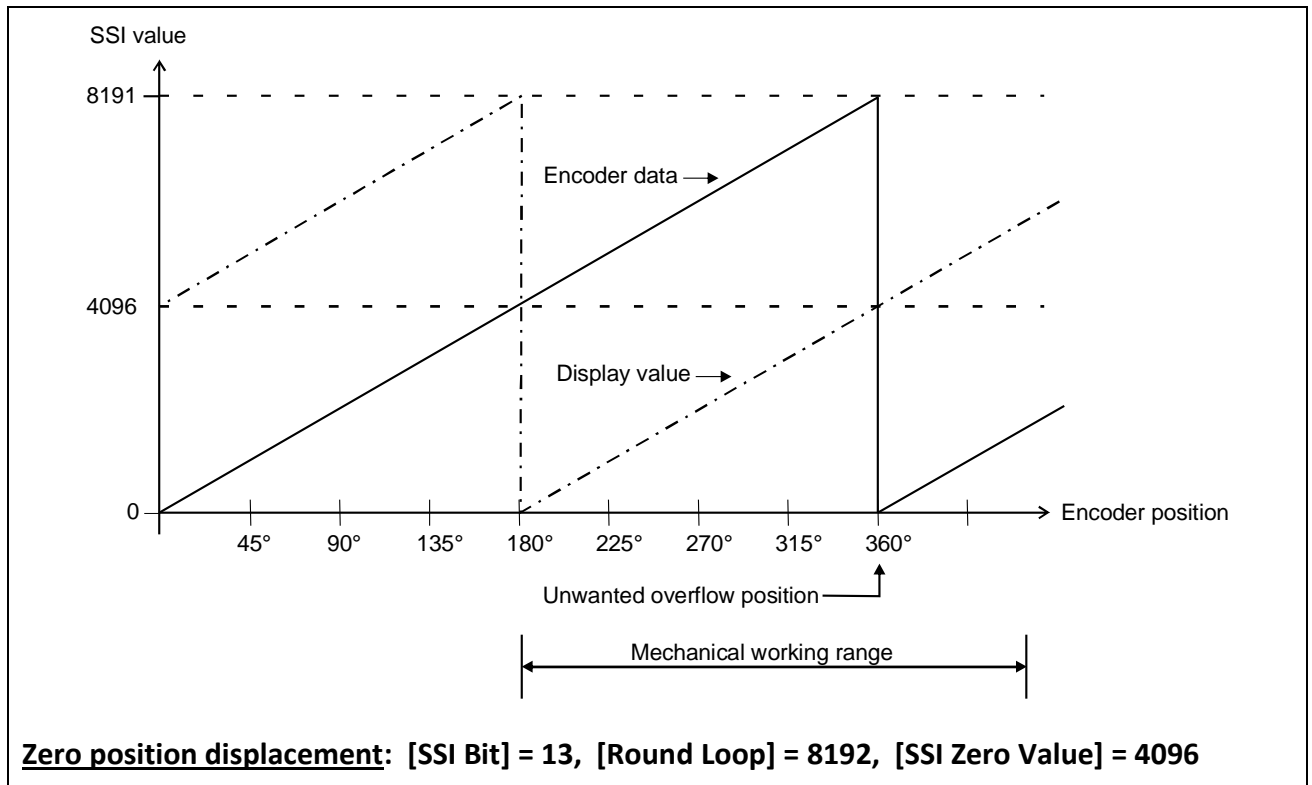

8.4.4. Splitting of SSI telegrams to several units

The Bit Blanking Function also allows to split the SSI telegram of one encoder to both encoder inputs, or to distribute it to two or more different SSI indicator units. As a typical application the figure below shows how to separate the angular information within one turn (16 bit) and the number of turns (12 bit) with a 28 bit Multiturn Encoder.

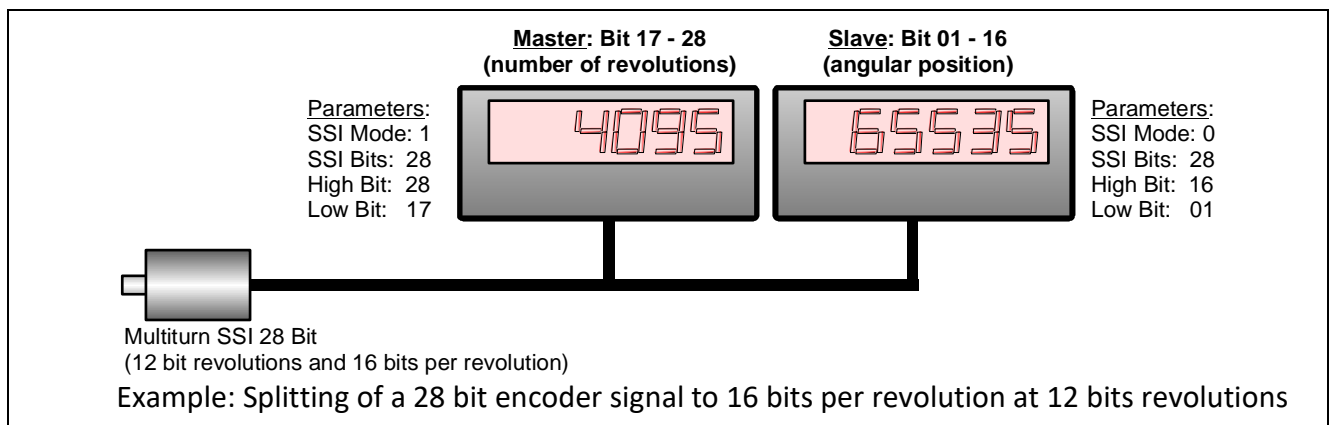

8.4.5. Hints for Use of the Linearization Function

The diagram below explains the difference between Linearization Modes 1 and 2:

Linearization Mode = 1

Linearization Mode = 2

- **x-registers** are to set the numeric counter value that the unit would display without linearization
- **y-registers** are to set the numeric value that should be displayed instead (i.e. the y3 setting will replace the display value x3)
- between the interpolation points the unit automatically uses linear interpolation
- x-registers have to use continuously increasing values, i.e. the lowest display value must be set to register x0, and the highest display value must be set to x15
- Independent of the selected linearization mode, the possible setting range of all registers x0, y0, ... x15, y15 is always -199999 ... 999999.
- For measuring values outside of the defined linearization range, please note:
 - all measuring values < x0 will be substituted by y0.
 - all measuring values > x0 will be substituted by y15.

8.4.6. Error Messages

The device will produce the following error messages:

Er.t. 1	Error: Time-out Encoder 1 (with Slave operation) Clock signal of remote Master is missing or out of expected timing
Er.t. 2	Error: Time-out Encoder 2 (with Slave operation) Clock signal of remote Master is missing or out of expected timing
Er.co 1	Error: Clock Count Encoder 1 (with Slave operation) The number of clocks per telegram does not match with the setting of the number of bits
Er.co 2	Error: Clock Count Encoder 2 (with Slave operation) The number of clocks per telegram does not match with the setting of the number of bits
Er.co d	Error: no Coincidence with "Double-read" (Master operation) The double-read function did not produce two coincident data telegrams

To quit an error message please keep down key PRG for more than 3 seconds, or send an "Activate Data" command via serial link.

9. Appendix: Serial Communication Details

Serial communication with the indicator can be used for the following purposes:

- **PC setup of the unit, using the OSxx Operator software**
- **Automatic and cyclic transmission of data to remote devices like PC, PLC or Data Logger**
- **Communication via PC or PLC, using the communication protocol**

This section describes the essential and basic communication features only. Full details are available from the special SERPRO manual.

9.1. Setup of the Unit by PC

The parameterization of the device is realized via the serial interface with a PC and the operating software OS. You can download this software, free of charge, from our homepage <https://www.kuebler.com/software>.

Connect the counter to your PC as shown in section 4.6 of this manual. Start the OSxx Operator software. After a short initializing time you will see the following screen:

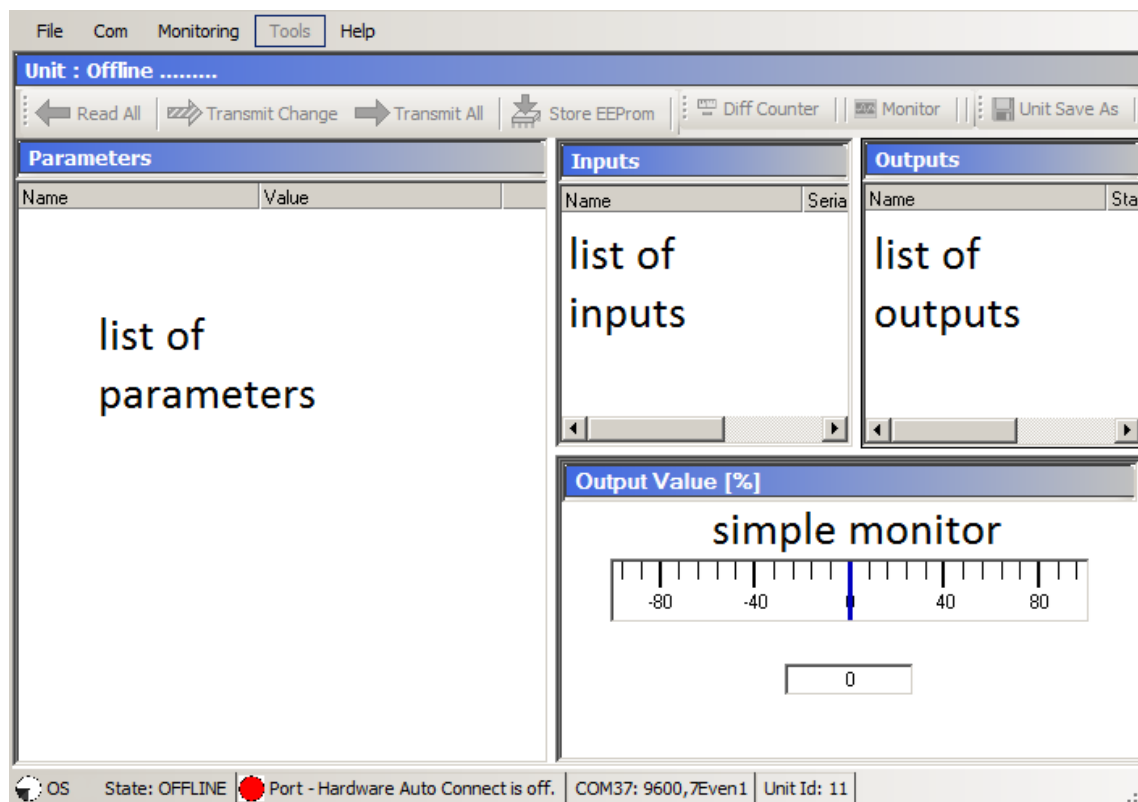

If your screen remains empty and the headline of your PC says „OFFLINE“, select „Comms“ of the menu bar and check your serial communication settings.

The edit field on the left shows all actual parameters and provides full editing function. The „File“ menu allows to store complete sets of parameters for printout or for download to a counter. When editing parameters, please use the ENTER key of your PC after each entry, to ensure storage of your data to the counter.

9.2. Automatic, Cyclic Data Transmission

Enter a time unequal to zero to [Serial Timer] (parameter F10.129)

Enter the serial code of the data you like to transmit to [Register Code] (parameter F10.130). In theory it is possible to transmit any of the available parameters and measuring values at any time, but practically it makes only sense to transmit one of the following values:

F10.130	Serial Code	Transmit Value
4	: 4	Actual SSI data of encoder 1
5	: 5	Actual SSI data of encoder 2
6	: 6	Actual counter data of the incremental encoder
12	; 2	Actual level of the analogue output (models D95 only)
14	; 4	Actual display value of the unit

Depending of the setting of F10.128 the unit transmits in a cycle one of the following strings:

(xxxx = Indicator Data, LF = Line Feed [hex. 0A], CR = Carriage Return [hex 0D])

Leading zeros will be suppressed

	(Unit Nr.)										
F10.128 = 0 :	1	1	+/-	X	X	X	X	X	X	LF	CR
F10.128 = 1 :			+/-	X	X	X	X	X	X	LF	CR

9.3. Communication Protocol

When communicating with the unit via protocol, you have full read/write access to all internal parameters, states and actual counter values. The protocol uses the DRIVECOM standard according to DIN ISO 1745. A list with the most frequently used serial access codes can be found in the subsequent section.

To request data from the counter, the following request string must be sent:

EOT	AD1	AD2	C1	C2	ENQ
EOT = Control character (Hex 04)					
AD1 = Unit address, High Byte					
AD2 = Unit address, Low Byte					
C1 = Register code to read, High Byte					
C2 = Register code to read, Low Byte					
ENQ = Control character (Hex 05)					

The data string below shows in detail how to request the unit with No. 11 for transmission of the actual SSI value of encoder 1 (serial code : 4):

ASCII-Code:	EOT	1	1	:	4	ENQ
Hexadecimal:	04	31	31	3A	34	05
Binary:	0000 0100	0011 0001	0011 0001	0011 1010	0011 0100	0000 0101

Upon correct request, the counter will respond:

STX	C1	C2	x x x x x x x	ETX	BCC
STX = Control character (Hex 02)					
C1 = Register code to read, High Byte					
C2 = Register code to read, Low Byte					
xxxxx = Counter data *)					
ETX = Control character (Hex 03)					
BCC = Block check character					

*) Leading zeros will not be transmitted

The Block-Check-Character represents the EXCLUSIVE-OR function of all characters from C1 to ETX (both comprised).

To write to a parameter, you have to send the following string:

EOT	AD1	AD2	STX	C1	C2	x x x x x x x	ETX	BCC
EOT = Control character (Hex 04)								
AD1 = Unit address, High Byte								
AD2 = Unit address, Low Byte								
STX = Control character (Hex 02)								
C1 = Register code to write, High Byte								
C2 = Register code to write, Low Byte								
xxxxx = Value of the parameter								
ETX = Control character (Hex 03)								
BCC = Block check character								

Upon correct receipt the unit will respond by ACK, otherwise by NAK.

Every new parameter sent will first go to a buffer memory, without affecting the actual counting process. This function enables the user, during normal counting operation, to prepare a completely new parameter set in the background.

To activate transmitted parameters, you must write the numeric value “1” to the “Activate Data” register. This immediately activates all changed settings at the same time.

Where you like the new parameters to remain valid also after the next power up of the unit, you still have to write the numeric value “1” to the „Store EEPROM“ register. This will store all new data to the EEPROM of the counter. Otherwise, after power down the unit would return with the previous parameter set.

9.4. Serial Access Codes

9.4.1. Communication Commands

Function	Code
Activate Data	67
Store EEPROM	68

These commands have to be sent to the unit every time after one or several new parameters have been transmitted, in order to activate or to store the new values. Both commands are "dynamic", i.e. it is sufficient to just send the data value "1" to the corresponding code position.

Example: send the command "Activate Date" to the indicator with Unit No. 11:

ASCII	EOT	1	1	STX	6	7	1	ETX	BCC
Hex	04	31	31	02	36	37	31	03	33

9.4.2. Control Commands

To activate control commands (e.g. Reset) by serial link, the following steps are required:

- the desired command has first to be assigned to one of the front keys, as described in chapter 7.4.6. *)
- after this the corresponding key can be virtually activated by serial command (same as if you would push the key or activate the hardware input). This kind of command provides static operation. Sending "1" to the corresponding location will switch the command ON, it will remain on until you send "0" to the same location to switch the command OFF again.

Control Input / Front Key	Code
Key "UP"	63
Key "DN"	64
Key "Enter"	65

Example: Parameter F06.068 = 1, i.e. the command "Reset Encoder 1" has been assigned to the key "UP" (see 6.4.6).

Switch Reset Encoder 1 ON (Unit No. 11):

ASCII	EOT	1	1	STX	6	3	1	ETX	BCC
Hex	04	31	31	02	36	33	31	03	37

Switch Reset Encoder 1 OFF (Unit No. 11):

ASCII	EOT	1	1	STX	6	3	0	ETX	BCC
Hex	04	31	31	02	36	33	30	03	36

- *) Function code "9" (Start Serial Transmission) is incompatible with the serial handling of Control commands and will cause communication conflicts.

9.4.3. Actual Measuring Values

F10.130	Serial Code	Transmit Value
4	: 4	Actual SSI data of encoder 1
5	: 5	Actual SSI data of encoder 2
6	: 6	Actual counter data of the incremental encoder
12	; 2	Actual level of the analogue output (models D95 only)
14	; 4	Actual display value of the unit

10. Technical Data

AC power supply	24 V~ +/-10%, 15 VA
DC power supply	24V- (17 – 40V), ca. 100 mA (+ encoder currents)
Auxiliary outputs	2 x 5,2 VDC, 150 mA each 2 x 24V DC, 120 mA each
Inputs	2 universal encoder inputs (SSI / incremental, TTL-differential) 4 control inputs HTL (Ri = 3.3 kΩ) Low < 2.5 V, High > 10 V, min. pulse duration 50 µsec
Input frequency	1 MHz (SSI clock and data and incremental encoder frequency)
Switching outputs (all models)	4 high-speed transistors 5 - 30V, 350 mA each (b) Response time < 1 msec. (a)
Serial Interface	RS232, 2400 – 38400 Bauds
Analogue outputs (.D95 models only)	0/4...20 mA (load max.270 Ohm) 0...+/- 10V (load max. 3 mA) Resolution 14 bits, Accuracy 0.1% Response time < 1 msec. (a)
Ambient temperature	Operation: 0 - 45°C (32 – 113°F) Storage: -25 - +70°C (-13 – 158°F)
Plastic housing	Norly UL94 – V-0
LED display	6 decades high-efficiency red, 14.22 mm (0.56") or 8 decades high-efficiency red, 9.15 mm (0.36")
Protection class (front)	IP65
Protection class (rear)	IP20
Screw terminals	Cross section max. 1.5 mm ²
Approvals	CE compliant in accordance with EMC Directive 2014/30/EU Low Voltage Directive 2014/35/EU RoHS Directive 2011/65/EU UKCA compliant in accordance with EMC Regulations S.I. 2016/1091 Low Voltage Regulations S.I. 2016/1101 RoHS Regulations S.I. 2012/3032

(a) Continuous serial communication may temporarily increase response times.

(b) Diode or RC filtering is mandatory when switching inductive loads.

11. Dimensions

Models 575:

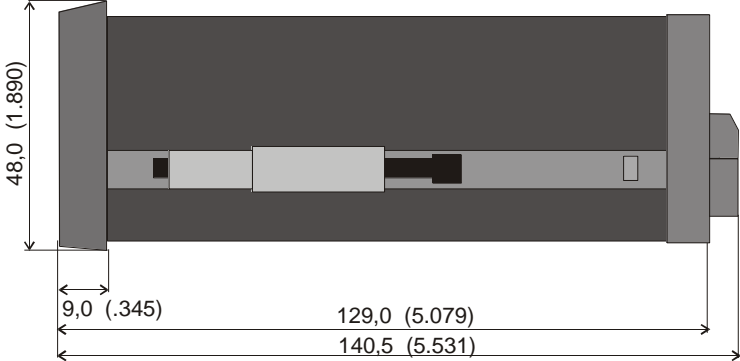
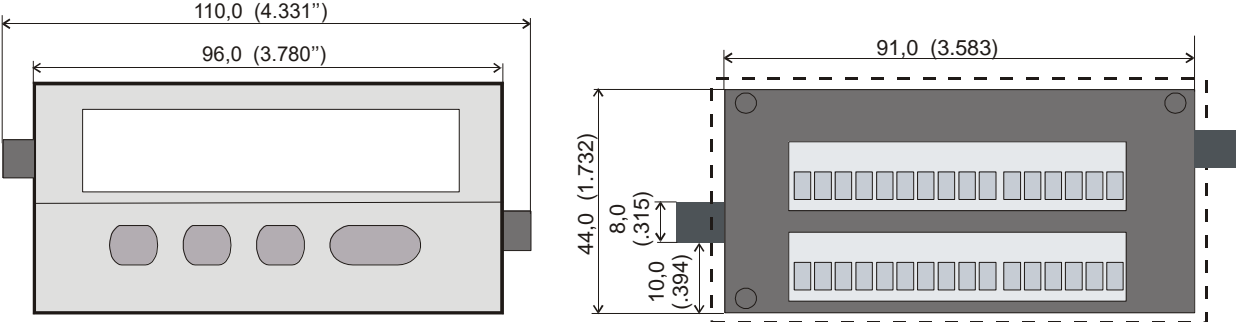

Panel Cut-Out: 91.2 x 44.8 mm (3.59 x 1.76")

Kübler Group

Fritz Kübler GmbH

Schubertstr. 47

78054 Villingen-Schwenningen

Germany

Phone +49 7720 3903-0

Fax +49 7720 21564

info@kuebler.com

www.kuebler.com